

SAME-DAY DENTISTRY WITHOUT COMPROMISES.

The 4-axis milling machine
for wet machining of blocks.

Z4



vhf
CREATING PERFECTION

**DIS
TING
TIVE**



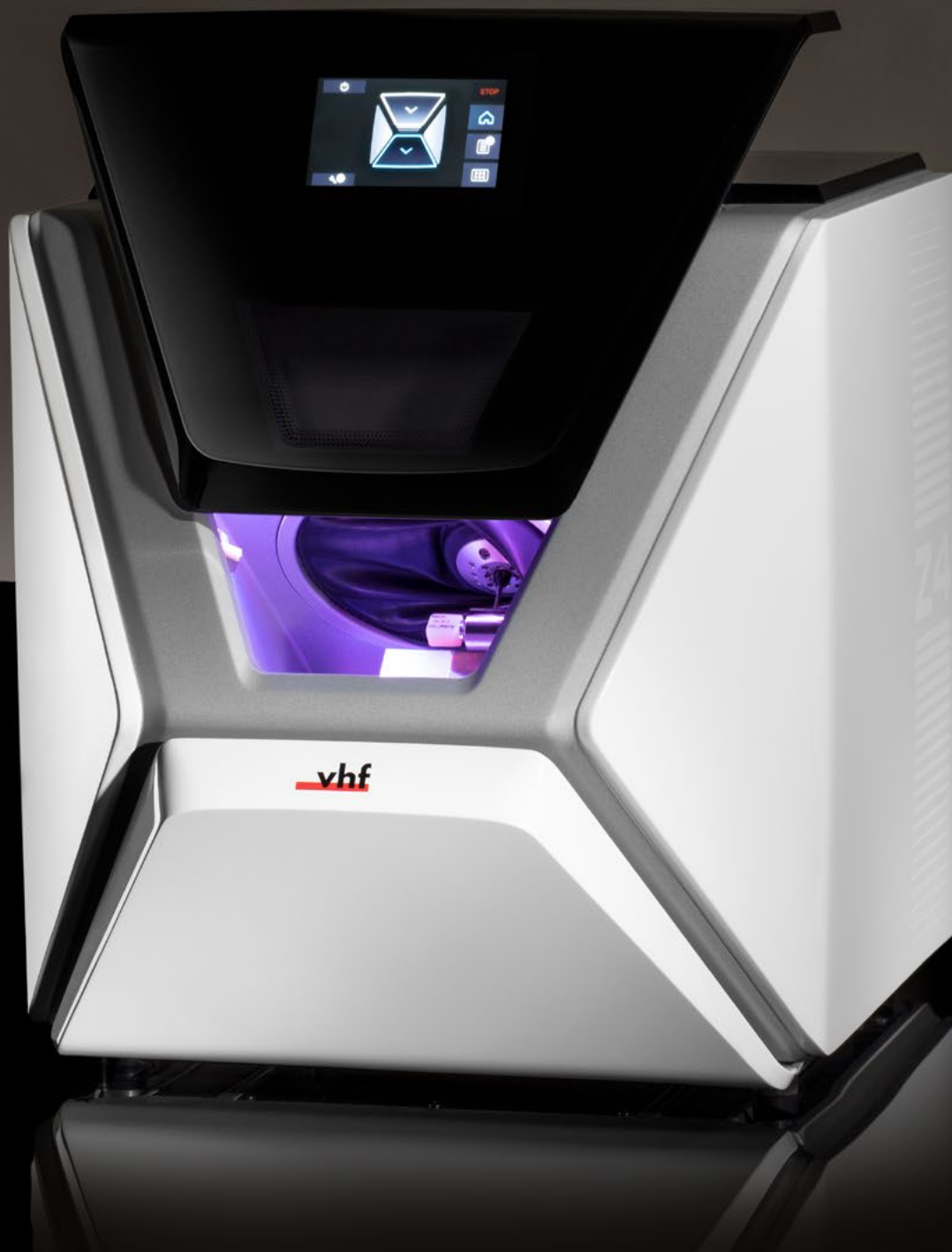

PERFECT
RESTORATIONS
IN RECORD TIME.

THE DENTAL
WET GRINDING
MACHINE FOR
BLOCKS.

THE MACHINE THAT WORKS LIKE YOU DO: PROFESSIONAL. INNOVATIVE. DIGITAL.

Intuitive operation meets comfort and speed – this is high-tech from vhf. The Z4 fits seamlessly into your workflow and is easy to operate.

For perfect restorations, you no longer need specialists who have attended time-consuming training courses. The Z4 can be operated by any member of staff after a short introduction and can be integrated into your daily practice routine without any additional effort. It only needs a power connection and does not require an external compressed air or water supply. As easy as that.

A close-up, low-angle shot of a silver and blue VHF device. The device features a prominent blue panel with a fine, circular perforated pattern. The silver body is sleek and modern, with sharp edges and a reflective surface. The lighting is dramatic, highlighting the textures and colors of the device against a dark background.

vhf





ARE YOU STILL CLAMPING OR ARE YOU ALREADY MILLING?

Can it go faster? Thanks to our **DIRECTBLOCK** Technology, you simply insert the desired material block conveniently via the front opening. As soon as you close the working chamber, the block is automatically fixated and the machine does its duty. After just a few minutes of successful machining, the Z4 workspace flap opens automatically so that you can remove the workpiece that has been milled perfectly to your requirements. And that's it – it couldn't be simpler! This is pure efficiency that saves you time and money.



PERFECT RESULTS. BECAUSE ANYTHING ELSE WOULD BE UNACCEPTABLE.

After all, that's what your patients expect from you. With the love for perfection, vhf has developed the Z4, which provides unrivaled quality standards for restorations. With this machine, you can reliably mill and grind in Ultra-HD in the micrometer range. The highest demands require a machine that performs its tasks precisely and without compromise.



MORE THAN A MACHINE. A STATEMENT.

The Z4 is a real eye-catcher, a modern monolith. A machine that is also a statement: uncompromisingly advanced and at the cutting edge – just like you and your practice.

The design of the Z4 is both aesthetic and functional. The user interface: clear, logical and intuitive to use. Our developers and designers have done a great job: Because it's a machine to be operated with pride and pleasure. This makes every user a big fan of the Z4.





AN INVESTMENT THAT PAYS OFF. FOR YOU AND YOUR PATIENTS.

The Z4 is your successful entry into same-day dentistry. The digital workflow not only makes treatments faster and more pleasant, but also gives you the opportunity to treat more patients with first-class dentures in just one session.

With the Z4, you have invested in a machine that is true German engineering. vhf has only integrated high-quality components, which meet maximum quality requirements and at the same time ensure the longest possible service life. Your Z4 will probably be in use longer than your tax office would like it to be.



**HIGH
PERFOR-
MANCE**



PRECISE RESULTS THROUGH HIGHEST QUALITY



- > The solid cast aluminum body is the basis for low-vibration machining.

WE HAVE GIVEN IT THE BEST PREREQUISITES. FOR RESTORATIONS IN ULTRA-HD.



A solid, internal cast aluminum body ensures particularly low-vibration operation. This is the prerequisite for highly precise and aesthetic restorations.



Industry-approved quality linear guides and drive technology, such as the rolled ball screws, enable you to achieve the most precise results.



Why not place the Z4 where your patients can see it? Thanks to internal insulation and a thick-walled TSG injection moulded housing, the Z4 is extremely quiet and can be set up at any location.



Extraordinary machining speed and highest surface quality thanks to the finely balanced high-frequency spindle with up to 100,000 rpm.



The Z4 has a repetition accuracy of an incredible 3 μm . This ensures that your restorations fit perfectly, every time.



The Z4 weighs impressive 66 kg – and requires minimal space.



State-of-the-art FPGA-based control technology from our sister company vhf elektronik GmbH guarantees you fast and smooth processes.

Left: Ball screws ensure highest accuracy at low wear. >

Right: the state-of-the-art control electronics provide best performance.

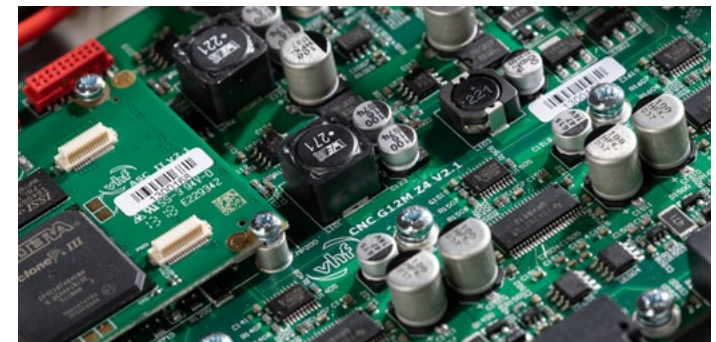
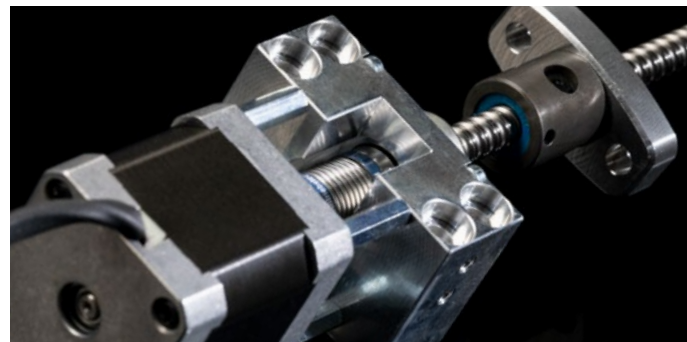



EVERYTHING THAT MAKES YOUR WORK EASIER. ALL INCLUSIVE WITH US.



The Z4 has an integrated PC – you don't need a notebook, tablet or mobile phone to work with it.



The touch display of the Z4 shows you all the important information – so you have all operating steps at a glance.



Thanks to the wifi connection, you are flexible and independent as far as the location is concerned. All you need is a socket for the power supply.



You will hardly hear it: A highlight of the Z4 is the built-in compressor. The extremely quiet and maintenance-free compressor supplies your Z4 reliably and directly with the necessary compressed air – regardless of the location.



With the Z4, you experience simple operation and maximum convenience. The **DIRECTBLOCK** Technology fixates and releases the workpiece fully automatically. For example, the tool-free block change: you can clamp the block in two seconds. No effort at all.

AS POWERFUL AS IT IS CONVENIENT. FOR PRECISE RESULTS IN MINUTES.

DIRECT MILL

The **DIRECTMILL** Technology is another highlight from vhf. As soon as the first paths of milling paths are calculated by the CAM, the machine already starts milling in parallel. This intelligent processing method saves you valuable time.

PURE WATER

Thanks to **PUREWATER** no grinding additives are needed, except for titanium processing – that's user-friendliness from vhf. For you, this means: absolutely environmentally friendly, no costly environmental regulations and no expensive disposal of process water.



The tool change is completely automatic. This saves you time and works absolutely reliably.





vhf

INTUITIVE WORKING MEANS NOTHING ELSE THAN: EVERYTHING RUNS PERFECTLY, WITH MINIMAL EFFORT.

For cleaning and filling, simply remove the easily accessible water tank – with only one grip.

The working chamber flap opens and closes automatically when the Z4 starts or finishes a job. The drawer is also self-opening and can be operated via the touch display – completely intuitively.

The maintenance indicator in the Z4's display provides you with brief and concise information about necessary maintenance stages that you yourself or a service technician can carry out.

The capacitive touch screen can even be operated with gloves. This is not only practical, but also saves you valuable time.



Operated as easy as smartphone: [^]
the clearly arranged display
of the Z4.

< The easy to remove tank only
needs to be filled with pure water.

Watch this video to see for [>]
yourself why dental experts
worldwide call this machine
“the future of digital dentistry”.



RELIABLY ACHIEVE THE BEST RESULTS. PATIENT BY PATIENT. DAY BY DAY. YEAR BY YEAR.

The colored interior LEDs inform you about the status of your job at a glance.

Color-coded tools and sensor-monitored magazines make it easier for you to load the machine and prevent mix-ups.

And highly appreciated by our users: for external support, the Z4 offers a webcam in the working chamber that allows a service technician to instantly and from any location gain an insight into your machine.

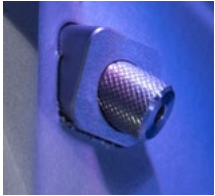
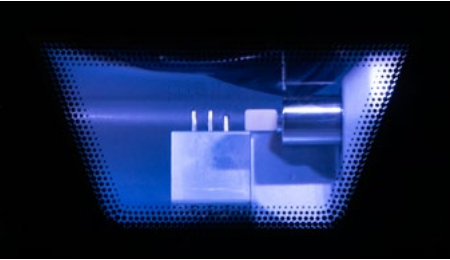

Always with insight: the integrated webcam.

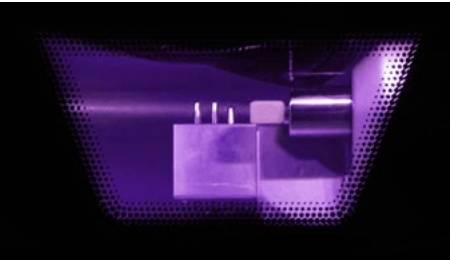
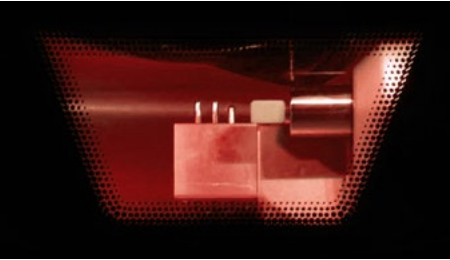

Always in view: the colored progress status lighting.

› Magnificently simple: when changing the workpiece, you can also replace the tool magazine in a single step. Due to the color coding, you always have an overview.



vhf



Whether composites, zirconia, titanium or glass ceramics – the Z4 can process just about anything.



MATERIAL, MANUFACTURER, INDICATION: ENJOY THE FREEDOM OF CHOICE.

Being open to all materials has always been a matter of course at vhf. Thus, vhf continuously expands the spectrum – and you benefit from constantly growing processing options.

You have the free choice of materials: Currently, you can process more than 50 block materials from a wide range of manufacturers – with rising tendency.

Choose from more than 800 titanium abutments from a wide range of manufacturers.

With the Z4 you can manufacture crowns, bridges, inlays, onlays and abutments from a wide range of materials. Easily create excellent restorations from PMMA, zirconia, composites, titanium or glass ceramic.



< Our Dental Portal gives you an overview of the validated block materials and titanium abutments. >

Exemplary selection of materials. New materials are continuously added. >



Easy and simple: >
Start the processing
of your workpiece
via the touch display

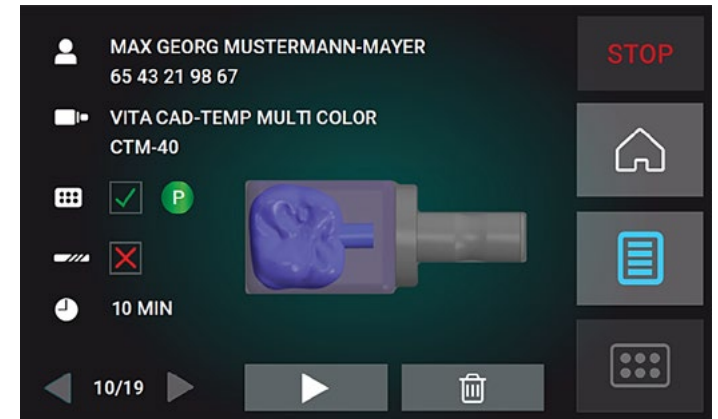

INGENIOUSLY SIMPLE – INTUITIVE WORK THROUGH INTEGRATED PROCESSES.

3shape 

exocad

Digital workflows have become an integral part of dentistry. With the integrated workflow of the Z4, you work from the intraoral scanner to the milling machine under one single user interface. Your Z4 is intelligently integrated into the CAD process and further simplifies the processing of blocks by the omission of the CAM component.

This is possible with the TRIOS Design Studio from 3Shape and the exocad ChairsideCAD* programs. The nesting is already done in the CAD and you only have to transfer the data to your Z4 thanks to the intelligent integration. From now on everything goes very quickly: insert the block, press Start on the touch display – and in mere minutes you have your finished restoration in your hand.

* Availability of materials and indications may vary depending on CAD provider; no restrictions via STL workflow.

THE FUTURE BELONGS TO OPEN SYSTEMS – LIMITLESS POSSIBILITIES THROUGH INTELLIGENT STANDARDIZATION



Software development has always been firmly anchored in our DNA. So, in line with our vision of "simplest operation with limitless application possibilities", we have also decided to raise the application range of the Z4 to a maximum level: Thanks to the open STL import, you – on request – also have a connection to all common CAD programs, in addition to the integrated workflow. Using this standardized data format, which has proven itself in the 3D world for over 30 years, all desired indications can be imported quickly, reliably and without loss of quality. This gives you the complete freedom of an open system and the maximum variety of indications and materials to choose from.

SCREW CHANNELS IN HIGHEST QUALITY

A scientific study by the University of Washington* confirms a key feature of the Z4: this milling and grinding machine can easily drill screw channels for hybrid implant restorations into ceramic blocks without the flexural strength significantly differing from the materials already pre-drilled. In fact, these so-called meso blocks are significantly more expensive and the nesting process is more complicated. So processing standard blocks with the Z4 means reduced material costs and lower inventory for you.

* Jack M. Keesler, DDS, MSD: Effect of milling screw-access channels on flexural strength of CAD/CAM ceramic materials. MSD Master's Thesis, University of Washington, 2019.



ACCURATE





**VHF DENTAL TOOLS ARE MANUFACTURED BY A PARTICULARLY
QUALITY-CONSCIOUS SUPPLIER: OURSELVES.**

PERFECTLY ADAPTED TO YOU AND YOUR Z4: TOOLS AND ABUTMENT HOLDERS FROM VHF.



▲ Triple tooth cutter for machining zirconia.



▲ Grinding tool for processing glass-ceramics and composites.

With our dental milling cutters and grinding tools, you can machine all materials commonly used in dental technology. The tools are available with differently optimized geometries and adapted coatings. This ensures that for each material the optimum balance is achieved between the best possible surface quality of the material to be machined and the longest possible service life of the tool. By the way, vhf produces all dental tools itself: in its modern six- and seven-axis precision grinding centers directly at the company headquarters in Germany.

Of course, vhf also offers you an impressive selection of abutment holders for all common systems. Choose from more than 800 titanium abutments from various manufacturers. Now you can easily complete your prefabricated abutments with the highest precision using the Z4.



The matching holder for the perfect > completion of your abutments.

A CLASS OF ITS OWN: SERVICE MADE BY VHF

As a pioneer in the dental CAM sector, service is a matter of heart for us. Together with our sales partners, we ensure that vhf users always achieve perfect results with their machine. For the technical service on our machines, we train our specialist dealers intensively and regularly at our vhf headquarters and online. For vhf customers, this means an optimal support by their certified dealer, efficient and convenient.

The vhf machines are manufactured according to the highest quality standards and offer a long life cycle with low maintenance intervals. Should a repair be necessary, our authorized dealers or the vhf service team will help quickly and reliably. And finally, the 24-month warranty is an important part of the vhf service package.



WHY PRAISE YOURSELF WHEN OTHERS DO IT FOR YOU?

As much as we are convinced of the technical finesse of the Z4, the most important thing is and remains how satisfied our customers are with the handling and performance of the dental machine. More about this – have a look right!



Alan Jurim, DDS

Director of Digital Dentistry at Touro Dental College, New York

“ The Z4 by vhf gives me the accuracy and flexibility in materials I need to accommodate more in-office workflows than we have ever seen before. Its user-friendliness and integrated compressor let us get up and mill in no time. All with incredible precision.



Dr. Ingo Baresel

President of the German Society for Digital Oral Impressions

“ The Z4 fits perfectly into the digital workflow, because it optimally meets the requirements for a same-day dentistry solution. It is important that intraoral scanners, design software and milling machines are seamlessly integrated.



John A Sorensen, DMD, PhD, FACP

Professor, Department of Restorative Dentistry, University of Washington.

“ I have to tell you that with the Z4 you finally got everything perfect. The system is gorgeous and completely self-contained. I can't thank you enough for letting me work with your system and I welcome the opportunity to show off and highlight this incredible vhf Z4 system!

THE NUMBERS SPEAK FOR THEMSELVES. TECHNICAL DATA.

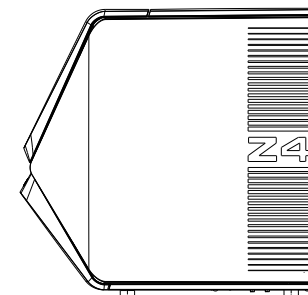
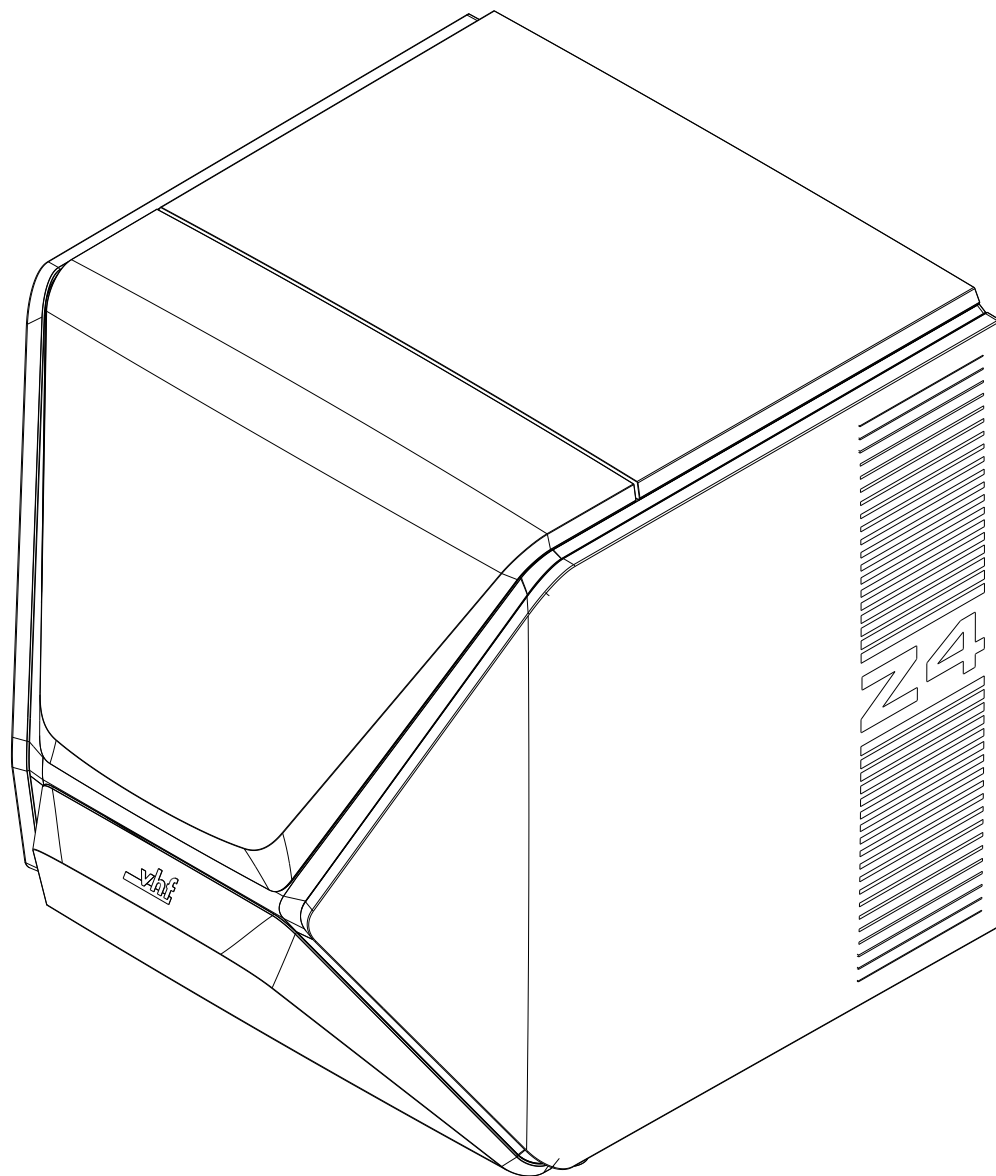

522 mm

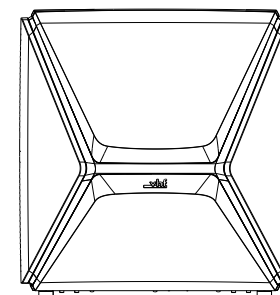

471 mm

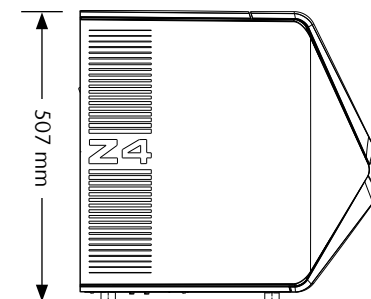

507 mm

GENERAL

Fields of application	Wet processing
Materials	Glass ceramics, titanium, zirconia, composites, plastic materials - Blocks up to 45 × 20 × 20 mm
Indications	Crowns, bridges, fully anatomical crowns and bridges, inlays, onlays, abutments, veneers, table tops

BASE SYSTEM

Construction	Machine bed made of solid cast aluminum body
Housing	Thick-walled TSG injection moulding, white high-gloss lacquer finish with workspace flap and combined drawer for water tank/tool inserts
Number of axes	4
Linear axes X-/Y-/Z-axis	Precision ball screws, rolled version · motors with resolution < 1 µm · ground precision steel guides · repetition accuracy ± 0.003 mm
Rotary axis A-axis	Rotary axis with high concentricity · Angle of rotation: 200°
Control unit	4-axis simultaneous control electronics with continuous path progression and dynamic pre-calculation · hardware-based real-time operating system with standardized command set · FPGA-integrated processor · updateable hardware · real-time path calculation via dedicated hardware engines in the FPGA · four-quadrant control of the motors for particularly smooth running · multiple analogue and digital I/Os for controlling the peripherals · integrated inverter for synchronous and asynchronous motors, electronic gate detection · Ethernet and USB interface
Compressed air generation	Internal compressed air supply with integrated sound insulation
Lighting	RGB LED lighting for process status display
Camera system	Integrated in the working chamber for easy remote support and possibility of internal recording
PC (integrated)	Intel® Atom™ E3950, 4 cores, 1.60 · 2.00 GHz, 8 GB RAM · additional HDMI display interface · WLAN
Display	Capacitive 5-inch touchscreen display fully integrated into the front flap for local operation of the machine

SPINDLE

General	High-frequency spindle, asynchronous with pneumatic tool clamping · sealing air to prevent debris from entering · automatic cone cleaning
Speed	Up to 100,000 rpm
Power	Peak power (Pmax): 340 watts · nominal power (S6): 220 watts · continuous power (S1): 170 watts
Bearing	Hybrid ceramic ball bearing · concentricity deviation at inner cone < 2 µm
Collet	Stainless steel collet with ceramic coating for tools with a shank diameter of 3 mm and max. 35 mm total length

AUTOMATION

Tool change	Tool magazine for 6 tools, removable and material-coded · Length measurement and tool breakage monitoring via precision measuring key
Workpiece change	The integrated DIRECTBLOCK Technology automatically takes over the clamping and releasing of the block or abutment holder to be machined
Access to the working chamber	Motorized opening and closing of the work chamber flap, movement parallel to the chassis
Access to combined drawer	Electric ejector for tool and water tank drawer

PROCESSING MODES

Wet	Multiple liquid nozzles on the spindle · Integrated cooling liquid (2 litres) with active carbon filter system · flow-sensor for monitoring the liquid supply · PUREWATER : no grinding additives except for titanium processing
------------	---

CONNECTION REQUIREMENTS

Compressed air	No compressed air required
Power	100 · 240 volts · 50/60 Hz, 750 watts
Data	10/100/1000 Mbit/s BaseT port (automatic detection) Ethernet via RJ-45 socket

ENVIRONMENTAL CONDITIONS

Operating temperature	Between 10 °C and 35 °C
Air moisture	Max. 80 % (relative), non-condensing

APPROVALS

All models	CE, VDE
North America model	UL, FCC (according to ANSI/UL 61010-1)

DIMENSIONS & WEIGHTS

Dimensions (W/D/H)	471 × 522 × 507 mm 471 × 737 × 608 mm with open door and drawer
Footprint (W/D)	400 × 305 mm
Weight	66 kg

SCOPE OF DELIVERY

CAM Software	DENTALCAM software included
Holder systems	Abutment holder devices for various systems (optional)
Accessories	Spindle service set · calibration set incl. micrometer · block holder maintenance set · brush for nozzle plate · cleaning brush · microfibre cloth · spare fine filter · active carbon pellets · Tec Powder (3 bags) · spare wiper for viewing window · tool magazine inserts (5 pieces) · Torque wrench · 2 Allen wrenches · drill bit (tool positions) · measuring pin · power cable · Ethernet network cable · carrying aid for transporting the machine · operating instructions

Home of high-tech:
the Z4 is manufactured
on the vhf campus,
south of Stuttgart.

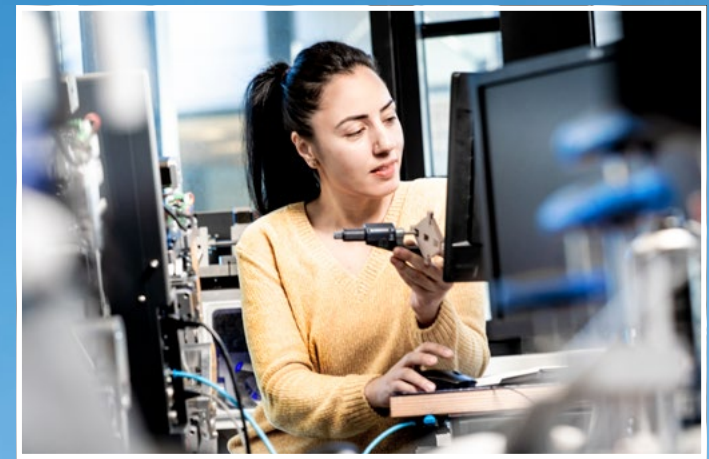



CREATING PERFECTION: FOR MORE THAN 30 YEARS.

What began in 1988 as a start-up by young technology enthusiasts has become today an internationally successful company. With more than 300 employees, the vhf group now manufactures high-quality products day by day. Made in Germany.

Where we come from: the home of high-tech

Meticulous perfectionism and high quality standards: that's what you expect from state-of-the-art technology from Germany. In Baden-Württemberg – the heartland of mechanical engineering and medical technology – we may even be a bit more obsessed with details. Here lays the origin of vhf.

Who we are: a team with a shared vision

At vhf, we are proud of our employees – people who think ahead: Motivated and conscientious, they shape the future of the company. Our claim *Creating Perfection* puts into words what distinguishes vhf: the constant striving for perfection. This concerns every product, every tool and all software from the company. Going the “extra mile” is not a vision at vhf, but everyday life. This is what makes us different, this is the secret of our success.

How we work: quality conscious, independent, transparent and sustainable

We produce milled parts for new machines on vhf milling machines with vhf tools – the best proof of their quality and practicability. We will gladly show you our production process during a guided tour at our facilities.

QUALITY RUNS IN THE FAMILY. DISCOVER THE R5 – MILLING REDEFINED.

You also want to process blanks? Then the big brother of the Z4 is the right mill for you. The R5 can also change blanks and blocks automatically and produce them for you around the clock. It features revolutionary innovations such as **DIRECTDISC** Technology and **DIRECTCLEAN** Technology.

More at vhf.de/en/R5





Z4



R5



CREATING PERFECTION

GET IN TOUCH.

HQ Europe

vhf camufacture AG
Lettenstraße 10
72119 Ammerbuch
Germany
+49 7032 97097 000
info@vhf.de | vhf.de

The Americas

vhf Inc.
80 Davids Drive, Suite 5
Hauppauge, NY 11788
USA
+1 631 524 5252
info@vhf.com | vhf.com

Asia

vhf Trading (Shanghai) Co., Ltd.
Room 2902, Building T1, Tianshan SOHO,
No. 421 Ziyun Road, Changning District, Shanghai
China
asia@vhf.de | asia.vhf.de

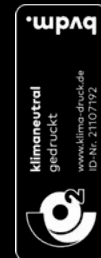

Printed on 100% recycled paper with FSC certificate • Subject to our Terms of Sale; we are glad to send them to you on request or you can download them at download.vhf.de • All trade and product names mentioned in this catalogue belong to their owners • Technical modifications and errors excepted • 09/2021