

SciCan

STATIM[®] B G4⁺

Vacuum Autoclave

Operator's Manual

- DE Benutzerhandbuch
- FR Manuel de l'utilisateur - USB
- IT Manuale per l'operatore - USB
- ES Manual del Operador - USB
- PT Manual do Operado - USB
- UK Інструкція користувача - USB
- RU Руководство пользователя - USB
- CZ Uživatel'ská příručka - USB
- DA Betjeningsmanual - USB
- HU Kezelői kézikönyv - USB
- NL Gebruikershandleiding - USB
- PL Podręcznik obsługi - USB
- RO Manual de utilizare - USB
- EL Εγχειρίδιο Χειριστή - USB
- CR Uputstvo za upotrebu - USB
- SV Användarmanual - USB
- SL Uživatel'ská příručka - USB
- FI Käyttöopas - USB
- NO Brukermanual - USB
- LT Naudojimosi instrukcija - USB
- BU Ръководство за експлоатация - USB





<https://www.scican.com/eu/products/autoclaves/statim/>

DE PDF Lesersoftware erforderlich.

Eine gedruckte Version erhalten Sie von der SciCan GmbH unter info.eu@scican.com

EN PDF reader software required.

For a hard copy, contact SciCan GmbH at info.eu@scican.com

FR Logiciel de lecture de PDF requis.

Pour une copie papier, contactez SciCan GmbH à l'adresse info.eu@scican.com

IT È necessario un software lettore di PDF.

Per una copia hardware contattare SciCan GmbH all'indirizzo info.eu@scican.com

ES Se requiere software para leer archivos PDF.

Póngase en contacto con SciCan GmbH en info.eu@scican.com para obtener una copia impresa.

PT É necessário utilizar um software de leitura de PDF.

Para obter uma cópia em papel, contacte a SciCan GmbH via info.eu@scican.com

UK Необхідне програмне забезпечення для читання файлів PDF.

Для отримання паперової копії зверніться до SciCan GmbH за ел. поштою info.eu@scican.com

RU Необходимо программное обеспечение для чтения файлов PDF.

Для получения печатной копии обратитесь в компанию SciCan GmbH по адресу info.eu@scican.com

CZ Je potřeba mít nainstalovaný software pro čtení PDF souborů.

V případě zájmu o tištěnou kopii kontaktujte společnost SciCan GmbH na adrese info.eu@scican.com

DA PDF reader software nødvendig.

For en printet udgave, bedes du kontakte SciCan GmbH på info.eu@scican.com

HU PDF-olvasó szoftver szükséges.

Nyomatott példányért lépjen kapcsolatba a SciCan GmbH céggel az info.eu@scican.com címen.

NL Software om pdf-bestanden te lezen is vereist.

Neem voor een papieren versie contact op met SciCan GmbH via info.eu@scican.com

PL Wymagany jest czytnik formatu PDF.

Aby otrzymać dokument w formie papierowej, należy skontaktować się z firmą SciCan GmbH pod adresem info.eu@scican.com

RO Este necesar un software de citire a fișierelor PDF.

Pentru o copie pe format de hârtie, contactați SciCan GmbH la adresa e-mail info.eu@scican.com

EL Απαιτείται λογισμικό ανάγνωσης PDF.

Για αντίγραφο σε έντυπη μορφή, επικοινωνήστε με τη SciCan GmbH στο info.eu@scican.com

CR Potreban vam je softver za čitanje PDF fajlova.

Za štampanu kopiju, kontaktirajte SciCan GmbH preko adrese info.eu@scican.com

SV PDF-läsare krävs.

För en papperskopia, kontakta SciCan GmbH på info.eu@scican.com

SL Vyžaduje sa softvér na čítanie PDF súborov.

V prípade záujmu o tlačenú verziu kontaktujte SciCan GmbH na info.eu@scican.com

FI Edellyttää PDF-lukuohjelmistoa.

Voit pyytää tulostetta SciCanilta osoitteesta info.eu@scican.com

NO PDF-leserprogram påkrevd.

For papirutgave, ta kontakt med SciCan GmbH på info.eu@scican.com

LT Reikalinga PDF skaitymo programinė įranga.

Spausdintą versiją galite gauti iš SciCan GmbH adresu info.eu@scican.com

BU Изисква се софтуер за четене на PDF.

За версия на хартиен носител се свържете със SciCan GmbH на info.eu@scican.com

For all service and repair inquiries:

In Canada +1 800-870-7777
United States: +1 800-572-1211
Germany: +49 (0)7561 98343 - 0
International: +1 416-446-4500
Email: techservice.ca@scican.com

Technical Service location:

SciCan GmbH
Wangener Strasse 78
88299 Leutkirch
GERMANY

COLTENE International Dental Group

Dent4You AG 

Bahnhofstrasse 2
CH-9435 Heerbrugg
info@dent4you.ch



Manufactured by:

SciCan Ltd.

1440 Don Mills Road,
Toronto ON M3B 3P9 / CANADA
T +1 416-445-1600
F +1 416-445-2727
TF +1 800-667-7733



SciCan GmbH
Wangener Straße 78
DE-88299 Leutkirch



Coltène/Whaledent GmbH+Co. KG
Raiffeisenstraße 30
DE-89129 Langenau

Coltène/Whaledent AG

Feldwiesenstrasse 20
CH-9450 Altstätten

US

Coltene/Whaledent Inc.
235 Ascot Pkwy.
Cuyahoga Falls, OH
44223, USA

Quick Start Guide

1. Switch the autoclave ON.

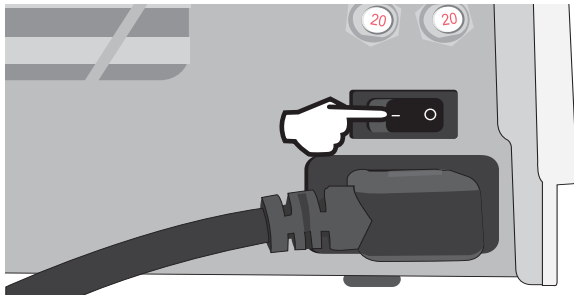

2. Ensure there is high quality distilled water in the reservoir.

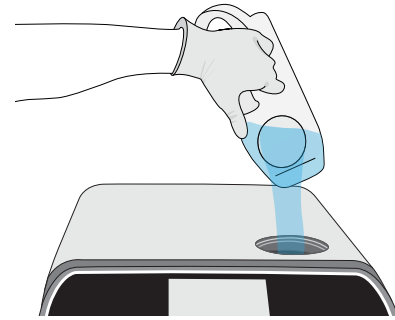

IMPORTANT! Never Use Tap Water.

More information in *Section 2.4*

3. Check that both red drain tubes are installed.

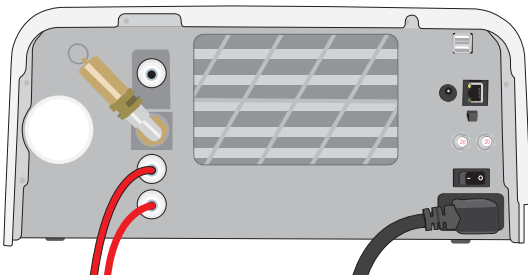

More information in *Section 2.3*

4. Turn the latch to open the drawer.

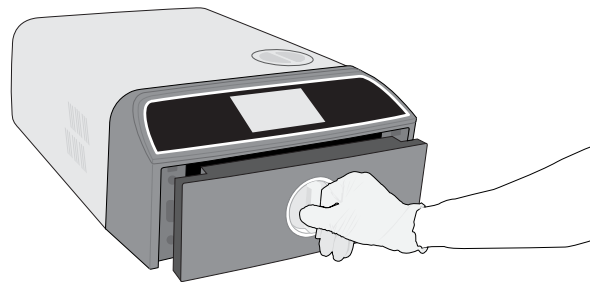

More information in *Section 1.7*

5. Insert the load.

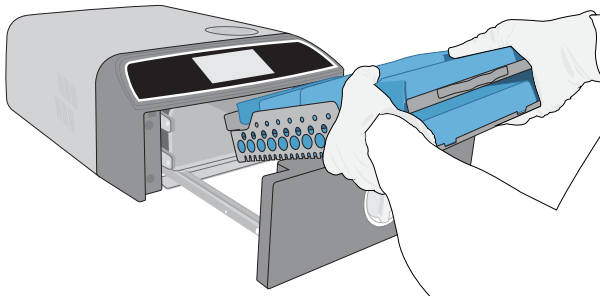

More information in *Section 4*

6. Close and latch the drawer.

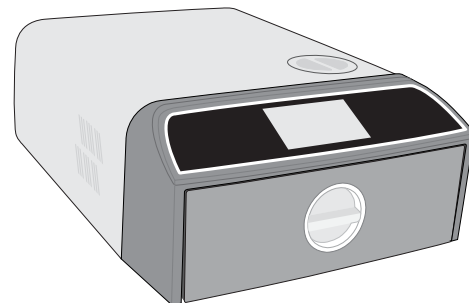

7. Select a cycle and holding time.



More information in *Section 6*

8. Press the **START** icon.



Contents

1. Your STAT/M B	4
1.1 Checking the Package Contents	4
1.2 Important Information about Using your STAT/M B	4
1.3 Operating Principles, Key Features and Safety Devices	6
1.4 Unit Overview	8
1.5 Touchscreen Overview	9
1.6 Using the Operation Screens	10
1.7 Unlocking the Drawer	10
2. Set Up	11
2.1 Installing your STAT/M B	11
2.2 Connecting and Powering your STAT/M B	12
2.3 Connecting your STAT/M B to a Drain or Waste Bottle	13
2.4 Filling your STAT/M B's Water Reservoir	15
2.5 Connecting your STAT/M B to a Network	18
3. Getting Started	20
4. Loading Instruments	21
4.1 Using the Drawer Trays	22
4.2 Wrapped Instruments	22
4.3 Unwrapped Instruments	23
4.4 Rubber and Plastic	24
4.5 Using Biological and Chemical Indicators	24
5. Using Your STAT/M B	25
5.1 Running a Cycle	25
5.2 Stopping a Cycle	27
5.3 Using the Delayed Start	29
5.4 Emergency Drawer Opening	30
5.5 Running a Vacuum Test	31
5.6 Running a Bowie-Dick/Helix 134°C Test	33
5.7 Running a Helix 121°C Test	34
5.8 Using the Custom Cycles	35
6. Sterilisation Cycles	37

7.	Using and Changing Settings	38
7.1	Setting Up Load Traceability with Usernames, Passwords and Process Enforced Function	39
7.2	Setting Drying Time	40
7.3	Setting the Stand-By Mode	41
8.	Storing, Retrieving and Printing Sterilisation Records	42
8.1	Retrieving Cycle Information Using the Touchscreen	42
8.2	Exporting Cycle Information Using the Unit's USB or Email	43
8.3	Connecting to Online Storage	45
8.4	Connecting to a Printer	46
8.5	Cycle Printout - Full Cycle	47
8.6	Cycle Printout - Stop Button Pressed	48
9.	Maintenance Procedures	49
9.1	Preventative Maintenance Message	49
9.2	Preventative Maintenance Schedule	49
9.3	Cleaning and Disinfecting the External Surfaces	50
9.4	Cleaning the Chamber and Trays	50
9.5	Cleaning the Chamber Filter	51
9.6	Draining the Water Reservoir	52
9.7	Cleaning the Reservoir Filter	52
9.8	Cleaning an External Fill Water Tank	53
9.9	Replacing the Bacteriological Air Filter	53
9.10	Replacing the Drawer Seal	54
9.11	Accessing Video Instructions	55
9.12	Enabling Remote Access for a Technician	56
9.13	Preparing the Unit for Shipping	56
10	Troubleshooting	57
11	Ordering Spare Parts and Accessories	60
12	Limited Warranty	61
13	Specifications	62
14	Sterilisation Cycle Profiles in Graph Format	63
15	Declaration of Conformity	64

1. Your STATIM B

1.1 Checking the package contents

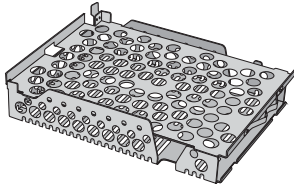

1 Instrument Tray Set



1 Waste Water Bottle with Lid

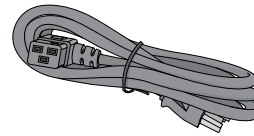

1 Power Cord

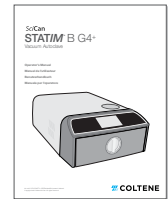

Operator's Manual



1 Memory Stick

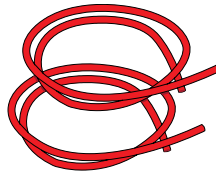

2 Exhaust Tubes



Direct-to-Drain Kit

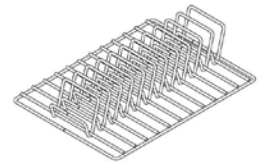

1 Pouch Rack

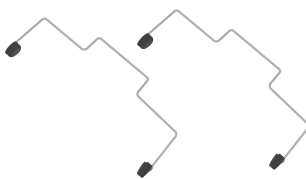

1 Tray Extractor

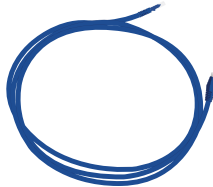

Ethernet Cable

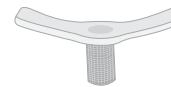

1 Chamber Filter



1 Bacteriological Filter

1.2 Important information about using your STATIM B

Intended Use

The STATIM B is a dynamic air removal (pre- and post-vacuum) table-top steam steriliser intended for use by a health care provider to sterilise medical products by means of pressurized steam.

It is suitable for the sterilisation of dental and medical instruments that are validated to be sterilised by steam. The STATIM B has not been designed to sterilise liquid loads, pharmaceutical products, bio-medical waste or materials not compatible with steam sterilisation. The processing of such loads may result in incomplete sterilisation and / or damage to the autoclave.

For more information about instrument suitability for steam sterilisation, consult the instrument manufacturers' reprocessing instructions.

This STATIM B autoclave is fully compliant with EN 13060.

Get to Know Your STAT/M B: Read this Manual

The details of installing, using and maintaining your STAT/M B are all in this manual. Please read this manual before operating the unit and keep it for future reference. Users should follow the operating instructions and maintenance schedule described in this manual. Contents of this manual are subject to change without notice to reflect changes and improvements to the STAT/M B product.

Water Quality

High quality distilled water is recommended for use in your STAT/M B. Deionized, demineralized, or specially filtered water can also be used as long as the water produced contains less than 6.4 ppm total dissolved solids (having a conductivity of less than 10 $\mu\text{S}/\text{cm}$). Never use tap water.

User Qualifications

The operation and maintenance of this unit should be restricted to trained and authorized personnel.

Repair and Modifications

Do not permit any person other than certified personnel to supply parts, service or maintain your STAT/M B. The legal manufacturer shall not be liable for incidental, special or consequential damages caused by any maintenance or services performed on the STAT/M B by a non-accredited third party, or for the use of equipment or parts manufactured by a third party, including lost profits, any commercial loss, economic loss, or loss arising from personal injury.

Never remove unit panels. Never insert objects through holes or openings in the cabinetry. Doing so may damage the unit and / or pose a hazard to the operator.

WiFi Compliance

This product complies with the requirements of the following EU Directive: EUROPEAN DIRECTIVE 2014/53/EU (Radio Equipment Directive). Compliance to this directive implies conformity to harmonized EU standards that are noted in the EU Declaration of Conformity for the WiFi module.

This device has been tested and found to also comply with the ETSI and Industry Canada limits for a Class B digital device pursuant to the U.S. Federal Communications Commission's Part 15 Subpart B. The total radiated energy from the main antenna connected to the wireless card conforms to the FCC limit of the SAR (Specific Absorption Rate) requirement regarding 47 CFR Part 2 Section 1093, when the autoclave was tested. The transmission antenna for the wireless card is located in the front fascia.

Incident Reporting

Any serious incidents should be reported to the manufacturer and/or the competent authority in which the user and/or patient resides.

Pay close attention to the following symbols that appear on the unit:



Caution: Refer to manual for details.



Medical Device



Caution: Hot surface and/or hot steam.



Caution: Risk of electrical shock.
Disconnect supply before servicing.



No tap water. Distilled, deionized, demineralized or specially-filtered water only.

CAUTION! Follow your local guidelines governing the verification of a sterilisation procedure.

1.3 Operating Principles, Key Features and Safety Devices

The STATIM 6000B is a 6-litre tabletop autoclave that uses steam to sterilise wrapped and unwrapped instrument loads typically used in dental and medical offices as well as laboratories. It has 11 sterilisation programs each with a selection of holding times and each equipped with optimized drying for fast, effective sterilisation. There are also two custom cycles.

How does it work?

The STATIM B uses a vacuum pump to draw air out of the chamber at the beginning and end of each cycle. The first vacuum draw sequence removes the air from the chamber before it starts the sterilisation part of the cycle. This ensures more efficient steam penetration into every load.

Another series of vacuum draws at the end of the cycle pulls the moist air from the chamber while heaters at the top and bottom of the chamber warm the walls to speed the drying. Fresh, filtered air is then pulled into the chamber to eliminate condensate. This increases evaporation and ensures the load is dry from the moment you open the drawer.

Forward thinking

The STATIM 6000B's WiFi-enabled G4+ technology records and monitors every cycle and can be configured to automatically send error codes to off-site service technicians who can troubleshoot a problem before it costs your operation time and money.

Features:

- › Space-saving design – with the same footprint as the STATIM 5000, the STATIM 6000B fits anywhere a cassette autoclave can. The recessed connections at the back keep tubing and power cord close to the unit so that it can be placed almost flush against a back wall.
- › Enhanced documentation mode adds more detail to your record keeping including indicator test results and content tracking labels.

Chamber

- › Mid-sized capacity chamber holds up to 2 large IMS cassettes or up to 12 pouched loads. At 6 litres, the STATIM 6000B is one of the largest tabletop drawer-type autoclaves on the market.
- › The simple rack-and-pinion drawer latching system is designed to reduce service issues.
- › Easy-to-use manual release for emergency drawer-opening lets you easily retrieve instruments in the event of a power failure. (CAUTION: Instruments retrieved after or during a power failure must be re-processed in the steriliser before use.)
- › Drawer monitoring system keeps a cycle from starting if the drawer is improperly closed.
- › Drawer-style autoclave allows for easy, one-handed opening and operation.

Programmable

- › Programmable chamber preheating and unit standby mode options ensures the STATIM 6000B is warm and ready when you need it.
- › Scheduled start option for every sterilisation program allows you to set the exact time you want to run a cycle to start the day with an instrument load.
- › Programmable features allow you to automate your daily vacuum tests to complete BEFORE the start of your workday.

Touchscreen

- › 5-inch touchscreen is one of the largest screens available for drawer-type autoclaves. With an 800 x 480 aspect ratio, the screen offers real-time monitoring of all the important sterilisation parameters as well as high resolution demonstration videos and instructions.
- › Easy-to-clean glass surface is responsive to gloved fingers so you can scroll and swipe through menu features as you would on a smartphone.
- › The LCD's large progress indicator animation lets you know exactly when your instruments will be ready once the unit has reached the sterilisation phase.
- › LED lights around the LCD display tell you the unit's status – from stand-by, to operating, to cycle complete – and let you know when the unit requires user attention.

Connectivity

- › Next generation G4+ features dual band WiFi that includes 5 GHz, and the 1 GB Ethernet connection allows for even faster user interface software updates. Intelligent G4+ technology also lets you integrate with the other G4 and G4+ units so you can share a printer for cycle records and labels.
- › Ability to connect securely to a third-party quality-control system means your sterilisation records can be safely managed and stored off-site.

Reservoir

- › Built-in reservoir holds enough water for 3 cycles, while the recommended auto fill and auto drain options can configure your STATIM B for easy daily use.
- › Low water indicator keeps the unit from starting a cycle if there is not enough water to complete it.
- › Integrated water quality sensor protects the unit from the long-term damage from the use of unsuitable water.
- › The automatic draining option to empty the reservoir at regular intervals helps reduce bio-film buildup.

Safety devices:

- › Steam generator overheat thermostat protects the unit from overheating.
- › Chamber pressure relief valve protects the unit and users from overpressure situations.
- › Circuit breakers protect the unit's electronics from power surges and can be easily reset by the user.
- › Overheat thermostats for the upper and lower band heaters protect the unit from overheating.

1.4 Unit Overview

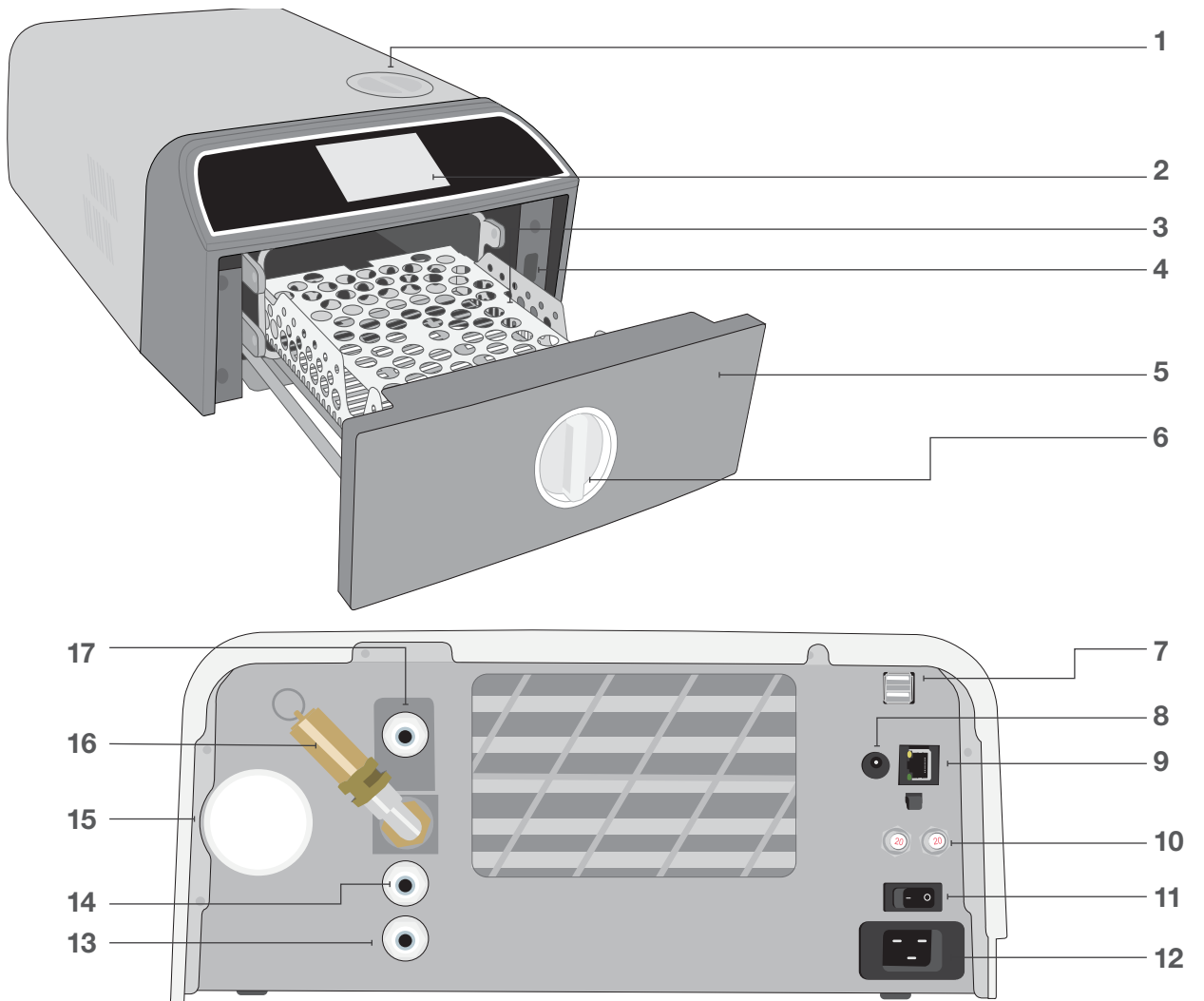

- | | | |
|-----------------------|---|--|
| 1. Reservoir top fill | 7. Dual USB ports | 13. Exhaust drain port |
| 2. Touchscreen | 8. Power port (5V DC) for optional external fill pump | 14. Reservoir overflow drain port |
| 3. Drawer rack | 9. Ethernet port | 15. Bacteriological air filter (bacteria-retentive air filter) |
| 4. USB port | 10. Fuse reset buttons | 16. Pressure relief safety valve |
| 5. Drawer | 11. Power switch | 17. Auto fill port (to connect fill options) |
| 6. Drawer latch | 12. Power cord input | |

LED Colours



WHITE
Unit is idle and ready for operation



RED
Cycle in operation



BLUE
Cycle complete



ORANGE
Cycle stopped or cycle fault condition

1.5 Touchscreen Overview

Home screen

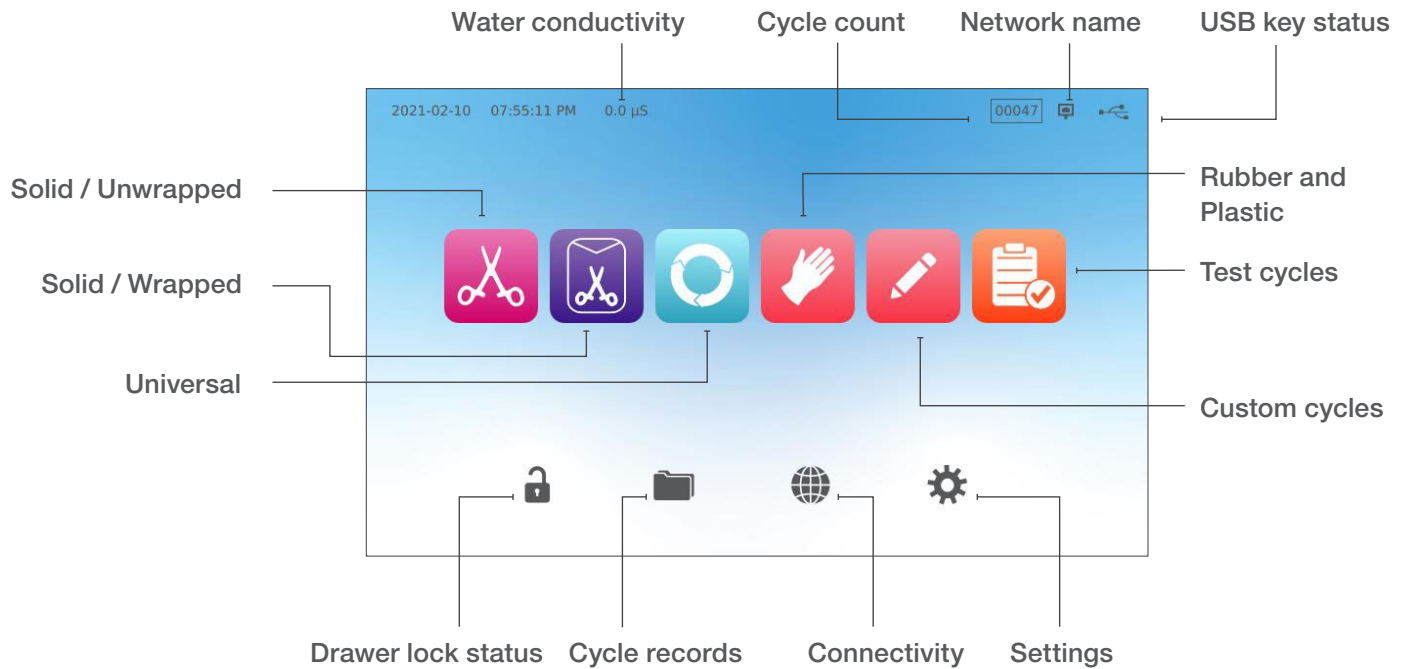

Changing the display from dark mode to light mode

Your STAT/M B's default screen mode is set to dark. To change it to light mode, go to **SETTINGS**, then **SYSTEM**, select **DISPLAY** and follow these steps:

1. On the **DISPLAY** screen, select light, press the check mark to save your change and then the **HOME** icon to return to the home screen.

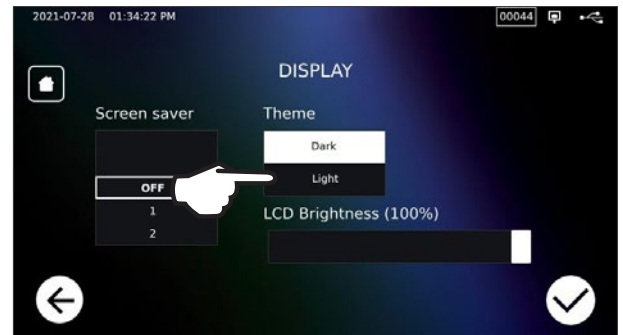

2. The home screen will now be in **light mode**.



1.6 Using the Operation Screens

1. Select a cycle and then select the holding time.



2. Press **START NOW** or **DELAYED START**.



3. Cycle in progress.



1.7 Unlocking the Drawer

The STAT/M B will lock the drawer when you select a cycle. To unlock the drawer, go to the home screen and press the flashing GREEN LOCK icon:

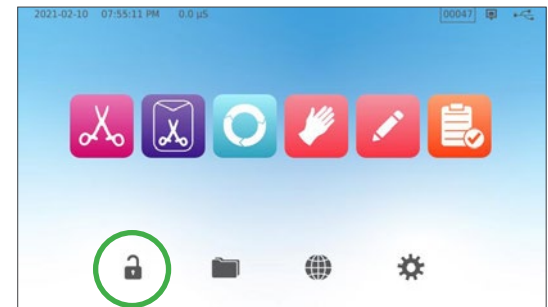

Lock Icon	What it Means	Action Required
	The drawer is locked because the chamber is still under pressure	Wait for lock to turn green
	The drawer is safe to open	Press the lock icon to unlock then unlatch the drawer
	The drawer remains locked, not safe to open	Power OFF the unit
	The drawer remains unlocked, unsafe to start cycle	Check the load to make sure the drawer is closing correctly

2. Set Up

2.1 Installing Your STAT/M B

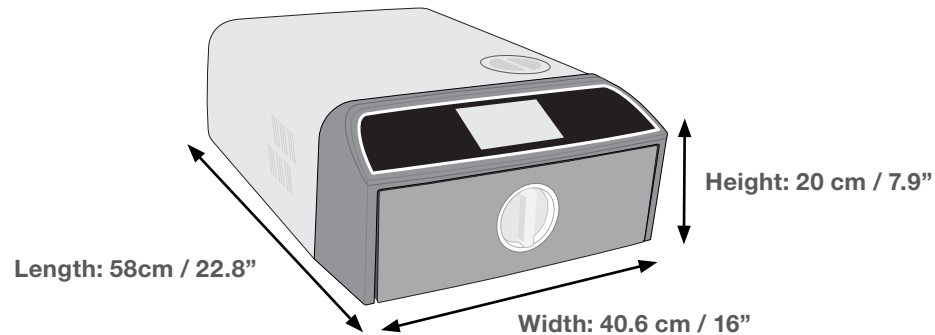

Requirements for Ventilation

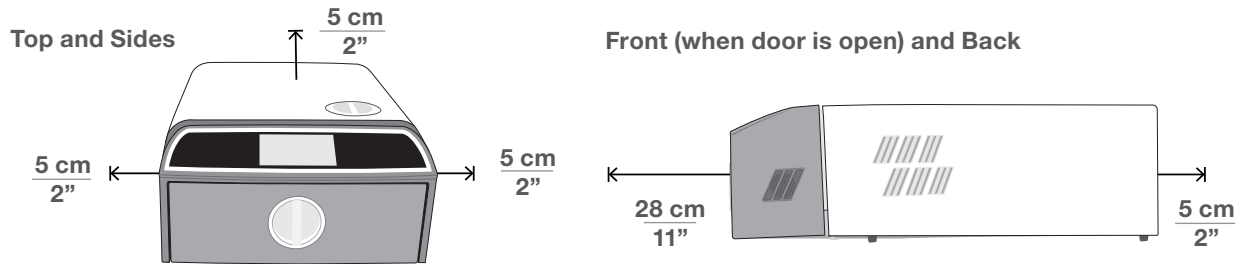

- › Leave a minimum of 5 cm (2 inches) between the top, sides and back of the unit and any wall or partition.
- › The unit vents warm air from the back.
- › Place the STAT/M B on a flat, level, water-resistant surface.
- › Weight (without water): 24 kg (54 lbs)
Weight (with water): 27.8 kg (61.3 lbs)

Temperature and Humidity

Avoid installing your STAT/M B in direct sunlight or close to a heat source such as vents or radiators. The recommended operating temperatures are between 5°C-40°C (41°F-104°F) with a maximum humidity of 80%.

Electromagnetic Environment

Your STAT/M B has been tested and meets applicable standards for electromagnetic emissions. While your unit does not emit any radiation, it may itself be affected by other equipment that does. We recommend that your unit be kept away from potential sources of interference.

Disposing of Packaging and Decommissioned Units

Your unit is shipped in a cardboard box. Please break down and recycle or dispose according to municipal requirements. A decommissioned steriliser should not be disposed of in the regular domestic waste. Doing so is potentially harmful to people and the environment. It has been used in a healthcare setting and represents a minor infection control risk. It also contains several recyclable materials that can be extracted and reused in the manufacture of other products. Contact your municipality to learn about its policies and programs governing the disposal of electronic devices.

2.2 Connecting and Powering Your STAT/M B

1. Ensure the power switch at the back left of the unit is in the OFF position and connect the power cord supplied to the power port at the back of the unit.



2. Connect directly to a power source. Don't use an extension cord.

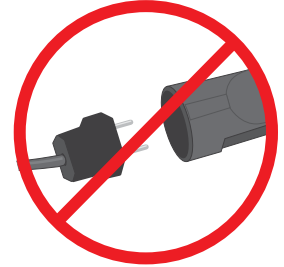
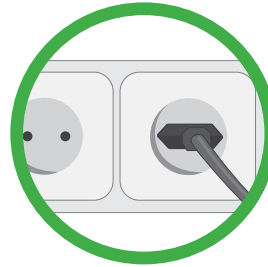

3. Turn ON the power switch located at the back left of the unit.

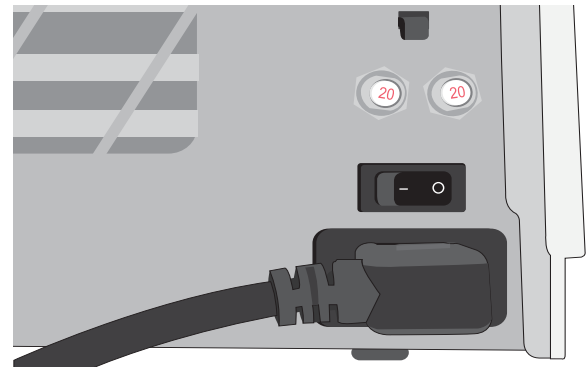

Electrical Connections

To power your unit, use properly grounded and fused power sources with the same voltage rating as indicated on the serial number label at the back of your STAT/M B.

- › **DO** use an outlet that is protected by a 15A breaker.
- › **DO** use a dedicated circuit, single phase 220-240 V 50~60Hz, 15A in Europe, Australia, New Zealand and Switzerland, and 220-240 V 50~60Hz, 13A for United Kingdom.

2.3 Connecting Your STAT/M B to a Drain or Waste Bottle

The STAT/M B produces waste water when the steam used to sterilise the load is exhausted from the chamber and condenses into water. This water can be drained from the unit into the waste bottle or directly to a connection on a drain pipe.

Connecting Directly to a Drain

For direct-to-drain connections, you will need to use the direct-to-drain hardware (provided with the unit).

Any new central drain point installation should be done by a technician. The drain points must be located on the upper portion of vertical drain pipe ABOVE the P-trap.

1. Insert the exhaust tube into the fitting on the back of the unit and pull gently to confirm it is holding correctly.
2. Cut the tube to length and slide the other end into the fitting to the port installed on the drain pipe.

IMPORTANT! It is best to have a direct-to-drain waste connection when using an automatic filling option. Use of an external waste bottle with automatic filling will require careful monitoring and frequent emptying.

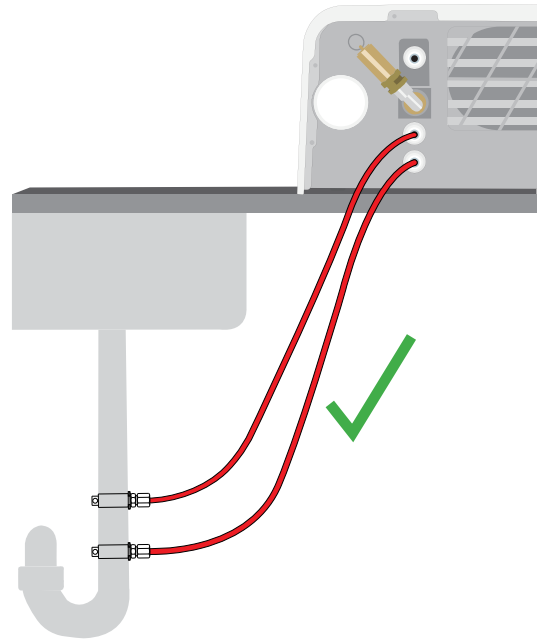

IMPORTANT! Avoid excess sagging in the drain tube, cut the tube to measure.

IMPORTANT! Tube should not be kinked, bent or otherwise obstructed. The connection point to the waste bottle or central drain must be lower than the autoclave's support surface otherwise the unit may not drain correctly.

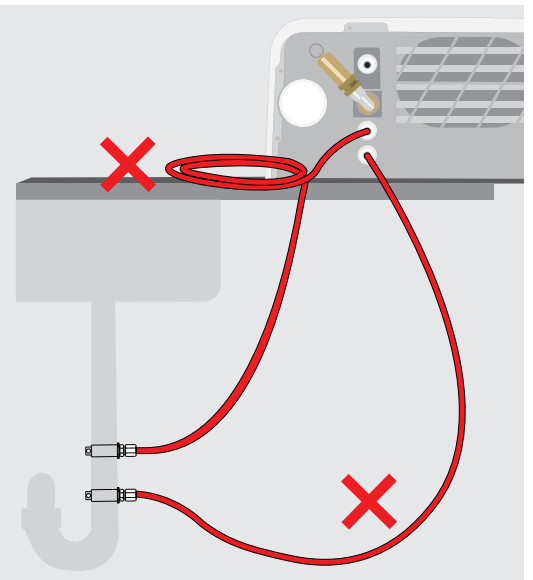

Connecting to a Waste Bottle

To connect the waste bottle to the STAT/M B, follow these steps:

1. Insert the exhaust tube into the fitting on the back of the unit and pull gently to confirm it is holding correctly.

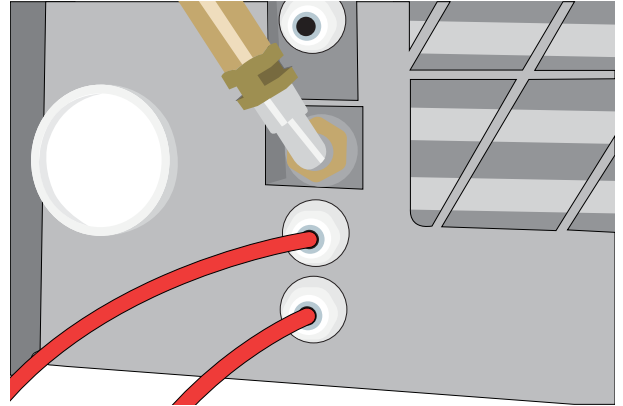

2. Cut the tube to length and slide the other end into the fitting on the bottle.
3. Unscrew the lid from the bottle.
4. Fill the bottle with water to the MIN line and re-install the lid and copper condenser assembly.
5. Place the waste bottle below the unit to allow proper drainage.

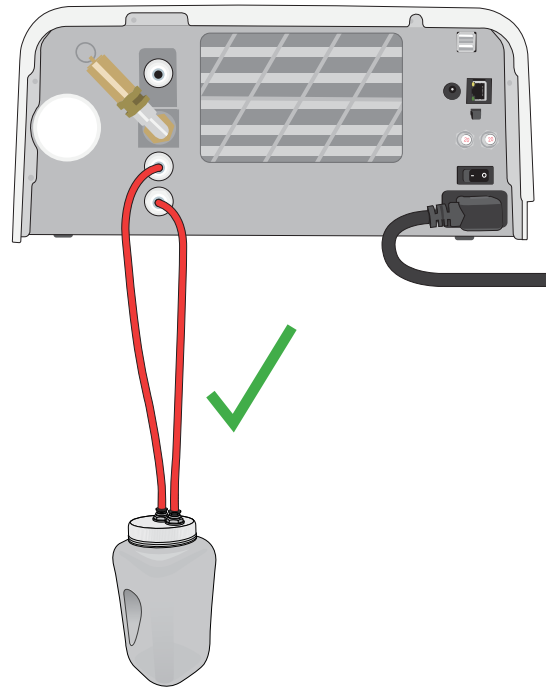

IMPORTANT! Avoid excess sagging in the drain tube, cut the tube to measure.

IMPORTANT! Tube should not be kinked, bent or otherwise obstructed. The connection point to the waste bottle or central drain must be lower than the autoclave's support surface otherwise the unit may not drain correctly.

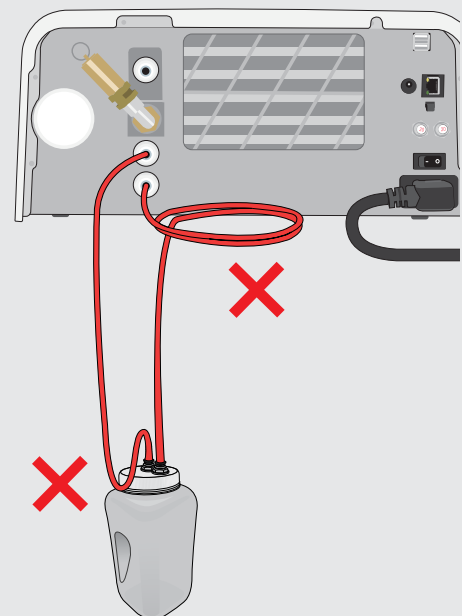

2.4 Filling Your STAT/M B's Water Reservoir

When filling the reservoir, only use distilled, deionized, demineralized, or specially-filtered water containing less than **6.4 ppm** total dissolved solids (having a conductivity of less than **10 $\mu\text{S/cm}$**).

NOTE: Impurities and additives in other water sources will cause the water quality sensor to protect the unit by preventing a cycle from starting.

To fill the water reservoir, there are three different methods:

1. Automatic fill using a WATER FILTRATION SYSTEM.
2. Automatic fill using an EXTERNAL WATER TANK AND AUXILIARY PUMP.
3. MANUAL fill. (Default)

Automatic Fill

If you are connecting your STAT/M B to an external filling device such as a water filtration system or external water tank and auxiliary pump, make sure your unit is set to the AUTOMATIC filling mode. Your STAT/M B's default filling option is set to MANUAL.

To change this setting, follow these steps:

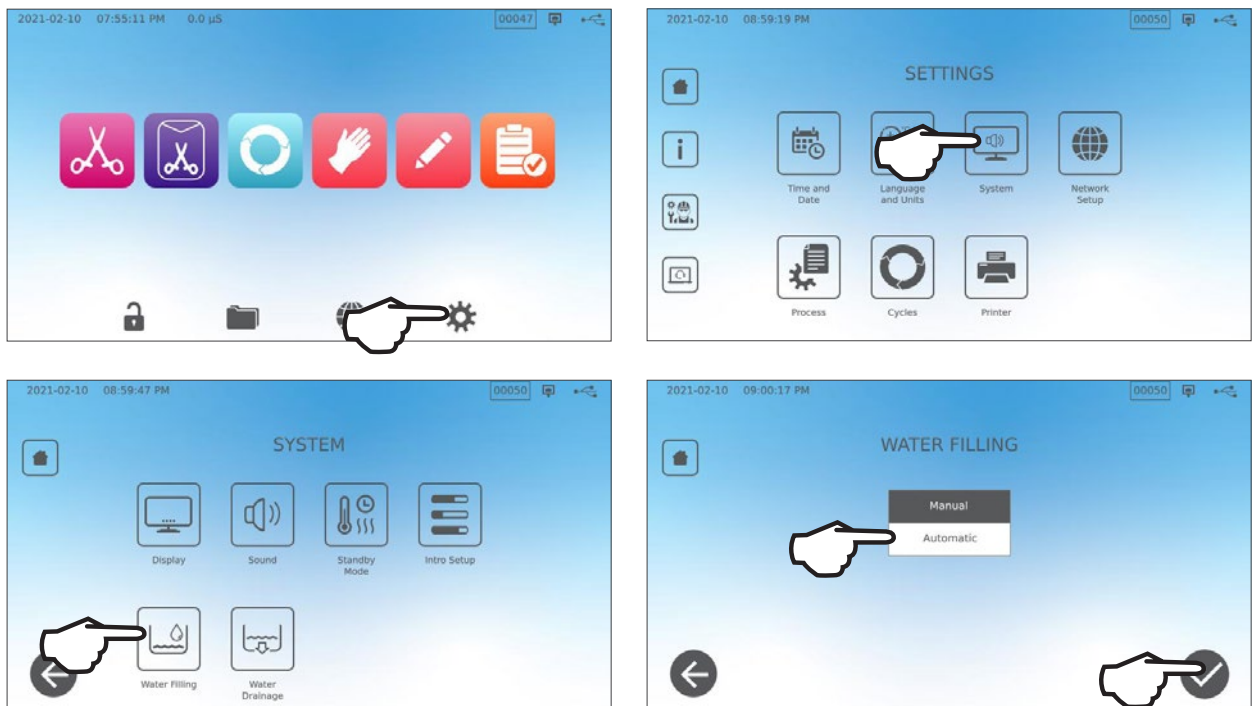

Automatic Fill using a WATER FILTRATION SYSTEM

When connecting your STAT/M B to an external filling device such as a water filtration system, make sure your unit is set to the AUTOMATIC filling mode. (See section above on setting the water reservoir filling mode.)

1. Connect the water filtration system's Teflon tube (or other suitable tube) to the automatic fill port at the back of the unit.
2. Ensure the tube runs freely from the water filtration system. It should not be sharply bent, kinked or obstructed in any way.
3. Open the valve on the water filtration system to fill the accumulation tank.
4. Open the accumulation tank's valve to facilitate the flow of water to the STAT/M B.
5. Go to the **HOME** screen and select any cycle to activate the filling system.

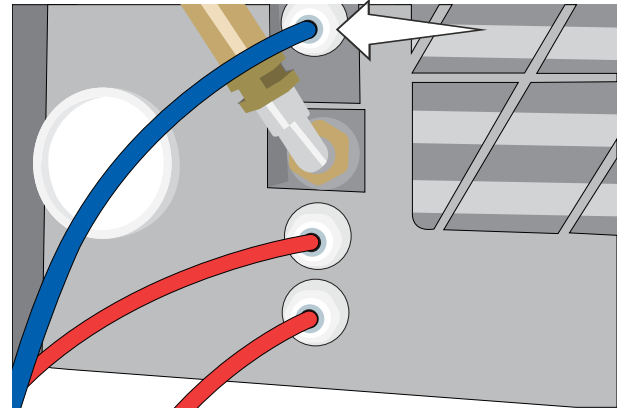

TIP

STAT/M B continually monitors the quality of the water in the reservoir. Check your water filtration system if you see the following screen: "Water conductivity high. Check water supply. Up to 30 cycles allowed when using current water quality."

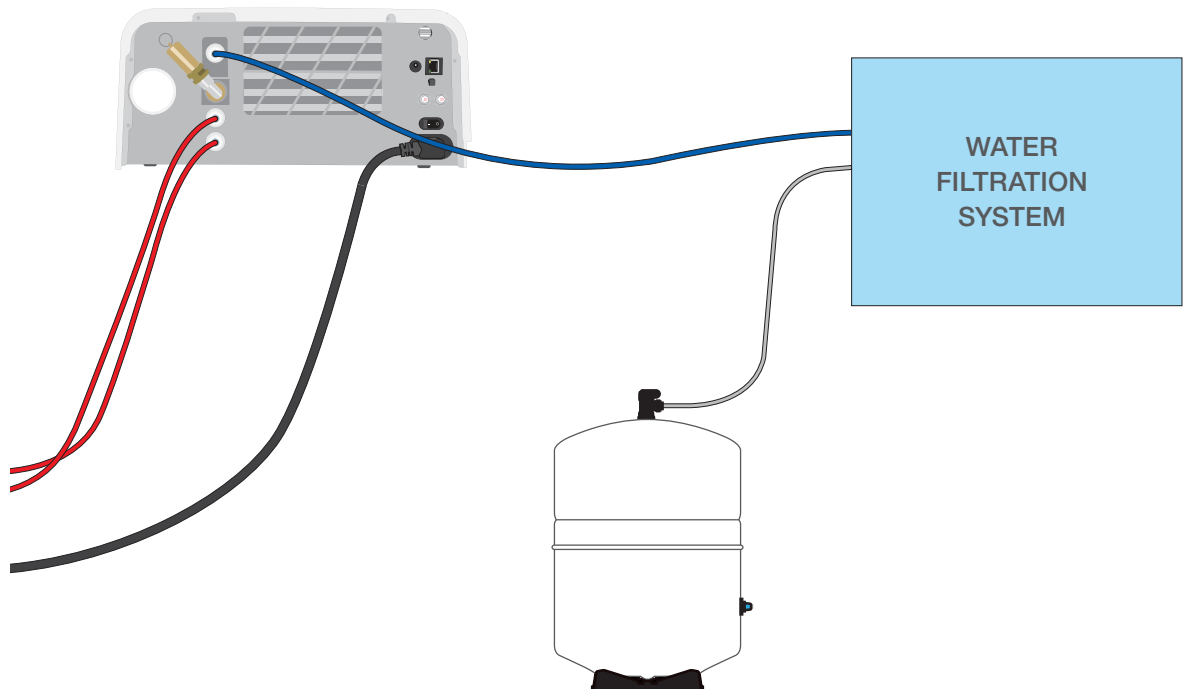

IMPORTANT! When selecting an automatic filling option, it is best to use a direct-to-drain waste connection. Use of an external waste bottle will require careful monitoring and frequent emptying.

Automatic Fill using an EXTERNAL WATER TANK AND AUXILIARY PUMP.

When connecting your STAT/M B to an automatic filling system such as an external water tank and auxiliary pump, make sure your unit is set to the AUTOMATIC filling mode (see section above on setting the water reservoir filling mode.)

An input hose can be connected to the STAT/M B from an external tank that uses an automatic water pump to feed the internal reservoir automatically when it reaches the minimum level. Be sure to monitor the water level of your external tank. The STAT/M B does not monitor the water level in the external tank and the auxiliary water pump should not run dry.

To use this method, you will need the automatic fill pump (sold as an accessory) and an external tank with a minimum diameter opening of 50mm (2") through which you can insert the pump.

To connect the automatic fill pump to the STAT/M B, follow these steps:

1. Connect the fitting at the end of the pump's tubing to the automatic fill port.
2. Connect the automatic fill pump's power source to the 5V DC power connection located at the back of the unit.
3. Fill the external tank with distilled water.
4. Place the submersible automatic fill pump in the external tank.
5. Go to the **HOME** screen and select any cycle to activate the filling system.

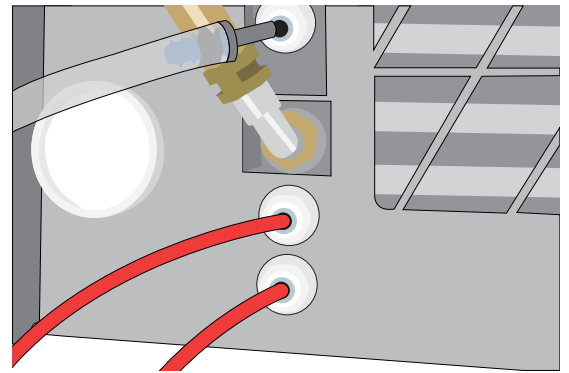

IMPORTANT! When selecting an automatic filling option, it is best to use a direct-to-drain waste connection. Use of an external waste bottle will require careful monitoring and frequent emptying.

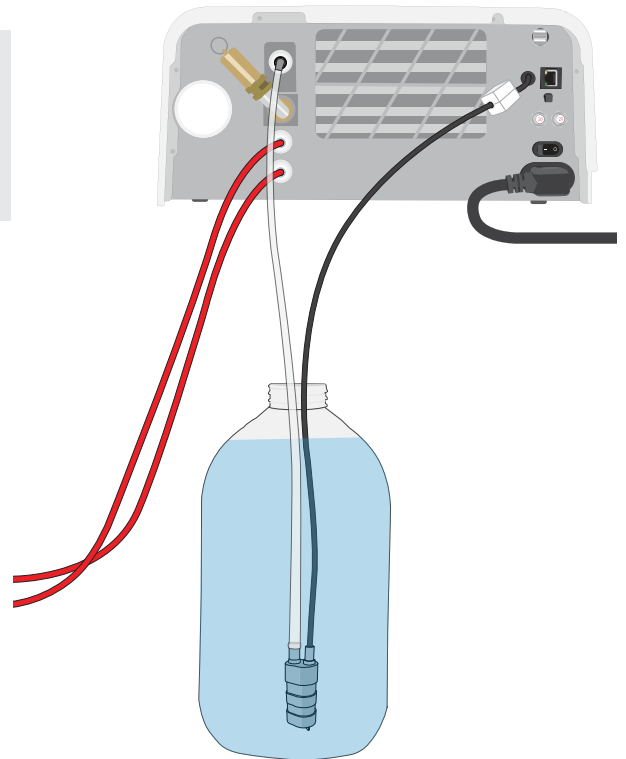

Manual Fill

Your STAT/M B's default filling option is MANUAL. If you are manually filling the reservoir, you do not need to change the unit's fill option settings.

To manually fill the reservoir, follow these steps:

1. Remove the reservoir cap.
2. Pour distilled water into the reservoir until almost full (a maximum of 1.2 L (0.32 US gallons)).
3. Replace and secure the cap.

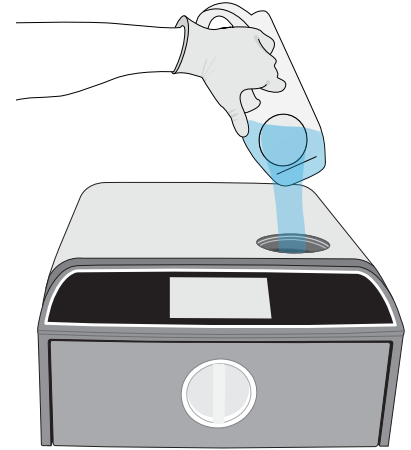

2.5 Connecting your STAT/M B to a Network

Connecting to a Wireless Network

From the unit's home screen, select the **SETTINGS** icon, then follow these steps:

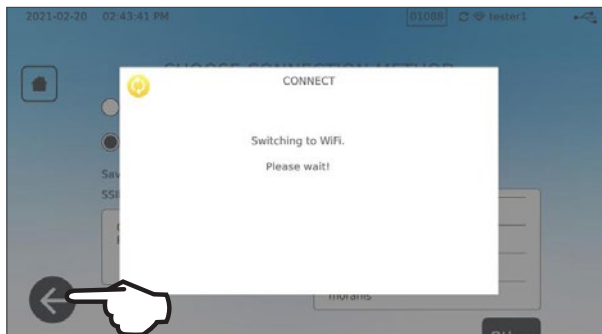
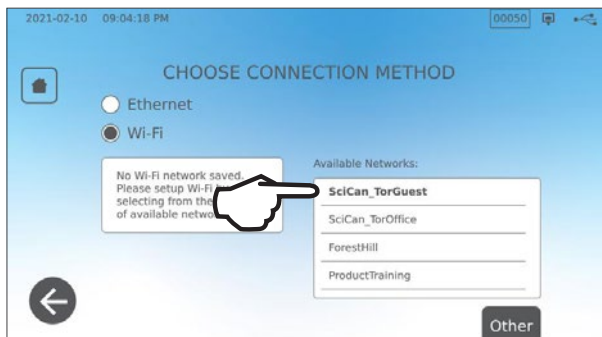
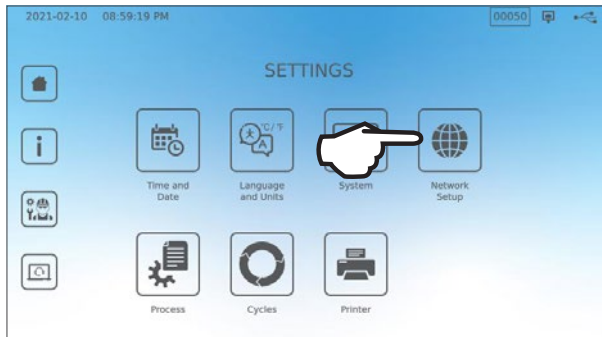

TIP You can also set up your unit's connectivity by going to the **SETTINGS** menu and selecting **Intro Setup** to initiate the **Intro Setup** wizard.

Connecting to a Wired Network

1. Connect Ethernet cable to port at back of unit.

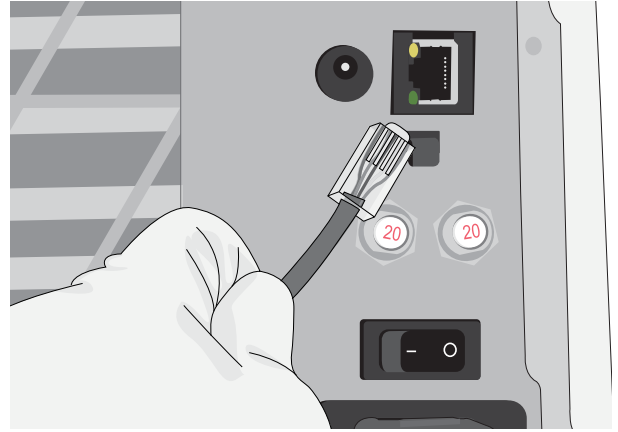

2. From the home screen, select the **CONNECTIVITY** icon.



3. Confirm that the unit is connected to both the Network and Internet and press the **HOME** icon to return to the home screen.



Data Security and WiFi

Ensuring your WiFi® connections are secure is an important element of safeguarding your organization's data. A WiFi network using WPA2™ provides both security (you can control who connects to it) and privacy (the transmissions cannot be read by others) for communications as they travel across your network. For maximum security, your network should include only devices with the latest in security technology – WiFi Protected Access® 2 (WPA2).

Tips for securing your network

- › Change the network name (SSID) from the default name.
- › Change the administrative credentials (username and password) that control the configuration settings of your Access Point/Router/Gateway.
- › Enable WPA2-Personal (WPA2-PSK) with AES encryption.

Wireless transmission considerations

To comply with U.S. Federal Communications Commission, ETSI, and Industry Canada Radiofrequency exposure compliance requirements, the antenna used for this transmitter has been installed to provide a separation distance of at least 20 cm (3/4") from all persons and must not be co-located or operating in conjunction with any other antenna or transmitter (the transmission antenna for the wireless card is located in the front fascia).

3. Getting Started

Preparing Your STAT/M B for First-Time Use

1. Check that the bacteriological filter is securely in place and that the two drain tubes are connected correctly.
2. Power ON the unit by using the switch located on the back left.
3. Follow the screen prompts to connect your STAT/M B using either WiFi or an Ethernet cable connection. This will automatically set the time and date for your unit and allows you to connect and register your unit to the online customer portal.

TIP

If you do not wish to connect your STAT/M B at this time, select a language and press the FORWARD button. Press the SKIP button to go to the end of the introduction. Set your time zone and country manually. Refer to Section 2.5 to learn how to connect your STAT/M B to a network.

4. Open the reservoir lid and make sure the unit contains distilled water or filtered water containing less than 6.4 ppm total dissolved solids (having a conductivity of less than 10 $\mu\text{S}/\text{cm}$).
5. Check that the USB storage device is plugged into the USB port. (You can use the front or back ports.)
6. Check your national and local guidelines for any additional protocols and tests required before using your unit.

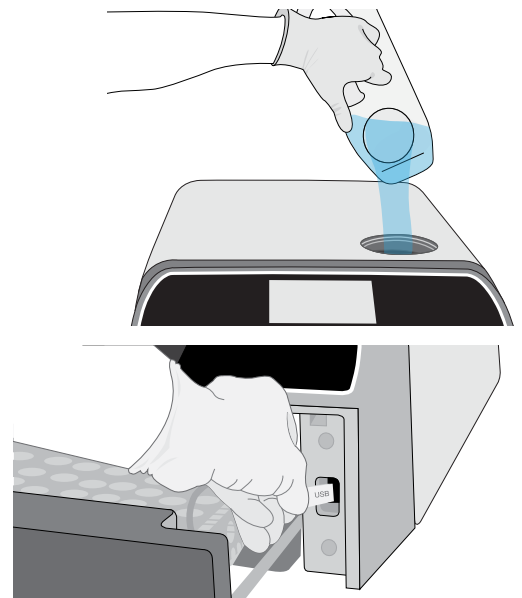
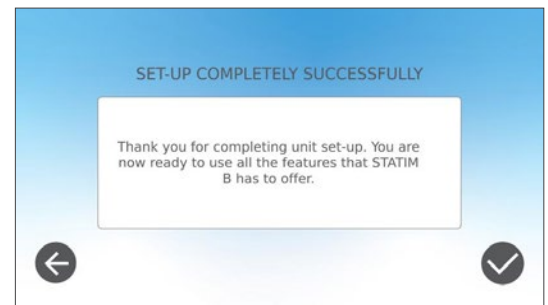
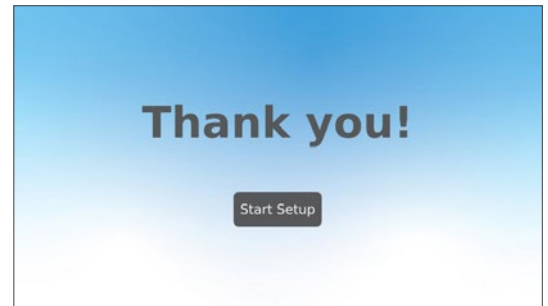
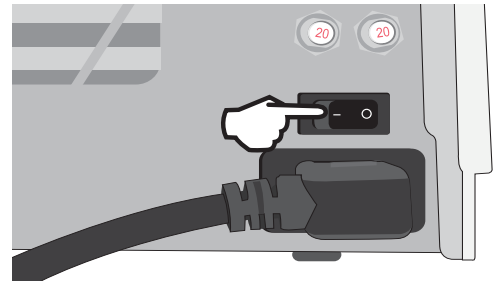
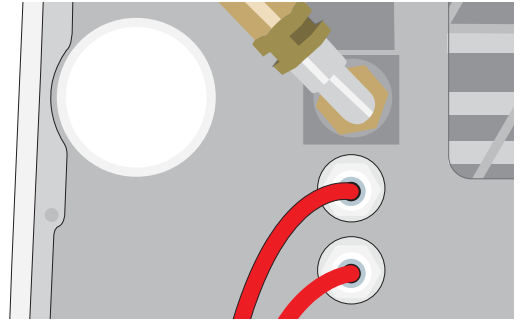

4. Loading Instruments

Before loading any instruments into the STATIM B, consult the instrument manufacturer's reprocessing instructions to confirm instruments can tolerate steam sterilisation temperatures.

The following materials can typically be sterilised with steam:

- › Stainless steel surgical/generic instruments
- › Carbon steel surgical/generic instruments
- › Rotating and/or vibrating instruments driven by compressed air (turbines) or mechanical transmission (counter-angles, tooth scalers)
- › Glass articles
- › Mineral-based articles
- › Articles made of heat-resistant plastic
- › Articles made of heat-resistant rubber
- › Heat-resistant textiles
- › Medical textiles (gauze, pads, etc.)

CAUTION! DON'T use the STATIM B to sterilise liquids or pharmaceutical products. This may result in incomplete sterilisation and/or damage to the autoclave.

Clean instruments before sterilisation

It is important to clean, rinse and dry all instruments before loading them into the autoclave. Disinfectant residues and solid debris may inhibit sterilisation and damage both the instruments and the STATIM B. Lubricated instruments must be wiped thoroughly and any excess lubricant removed before loading.

Load Type	Capacity per Tray	Total Capacity*
Solid Wrapped	1.3 kg (2.8 lbs)	2.6 kg (5.6 lbs)
Hollow Wrapped	0.5 kg (1.1 lbs)	1 kg (2.2 lbs)
Rubber and Plastic	0.5 kg (1.1 lbs)	1 kg (2.2 lbs)
Textiles	1.3 kg (2.8 lbs)	2.6 kg (5.6 lbs)

* Load capacities listed here are for the total weights of instruments and cassettes or containers not supplied with the unit. **DON'T** include the weight of the trays or pouch rack that are supplied with the unit when calculating your instrument load weights.



Instruments must be dry before they are loaded into the STATIM B for processing.

4.1 Using the Drawer Trays

The drawer trays can be loaded while in the unit or removed and loaded on a counter.

1. Lift the top tray out of the drawer to facilitate loading the lower tray.
2. Once you have loaded the lower tray, place the top tray back into position making sure the tabs sit securely in each corner, then load the top tray.

IMPORTANT! Always run the unit with the lower tray in place.

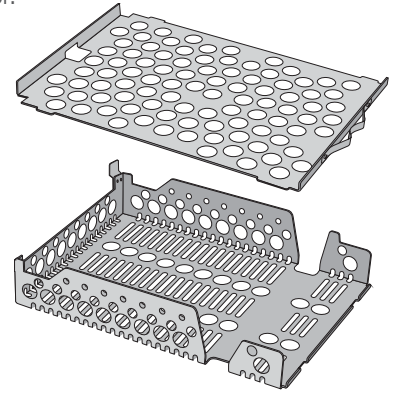

4.2 Wrapped Instruments

If you plan to store your instruments after sterilisation, wrap them according to the instrument manufacturer's instructions, select the appropriate wrapped cycle and allow it to run to completion. Unwrapped instruments, once exposed to ambient or external conditions, cannot be maintained in a sterile state.

- › **DO** ensure to use only sterilisation wraps and pouches that have been cleared for your market.



DON'T use 100% cellulose sterilisation wraps as these may require longer drying times.

Using pouches

CAUTION! Instruments in pouches or wraps that are not completely dry must be used immediately or reprocessed.

Using the STAT/M B pouch rack will enable you to process up to 12 pouches in a load. Pouches can be arranged vertically and if an edge must be folded, make sure it is folded on the paper side.

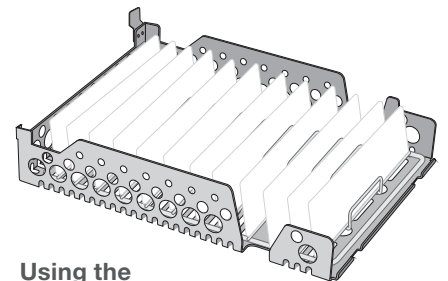

Using the pouch rack

The STAT/M B can also process pouches using the standard rack. In this configuration, load up to four pouches in each tray with the paper side up.

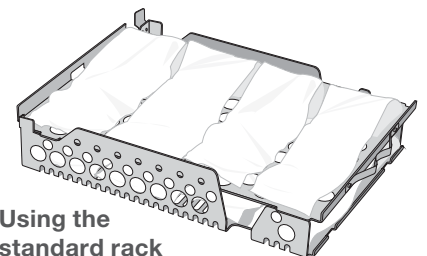

Using the standard rack

- › **DO** package instruments individually. If you are placing more than one instrument in the same pouch, ensure they are made of the same metal.
- › **DON'T** stack pouches or wraps. Stacking impedes drying and effective sterilisation.
- › **DON'T** store pouched or wrapped loads that are wet. If the wraps on the wrapped load are not dry when the load is removed, the instruments must be handled in an aseptic manner for immediate use or re-sterilised.

Using wrapped cassettes and containers

For wrapped loads, place a chemical indicator inside each of the wrappings.

When using wrapped cassettes:

- › **DO** ensure you always use suitably porous material (sterilisation paper, muslin napkins, etc.) and close the wrapping with adhesive tape designed for use in autoclaves.
- › **DON'T** close the wrap using staples, pins or other fasteners that could compromise the sterility of the load.

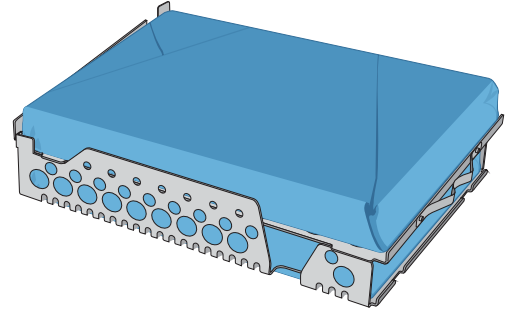

Combining wrapped cassettes and pouches

Load the wrapped cassette on the bottom tray and up to four pouches on the top tray, paper side up.

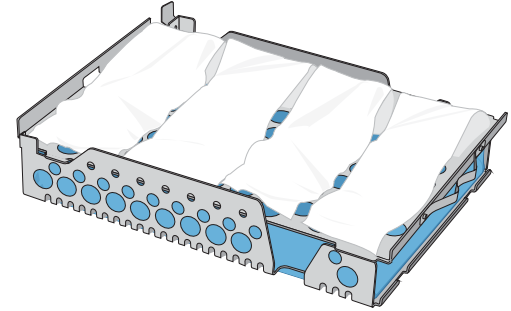

4.3 Unwrapped Instruments

Unwrapped instruments are also referred to as Immediate Use Instruments because once exposed to ambient or external conditions, they cannot be maintained in a sterile state.

If you plan to store your instruments after sterilisation, wrap them according to the instrument manufacturer's instructions, select the appropriate wrapped cycle and allow it to run to completion.

- › **DO** use the trays provided with your unit to hold unwrapped instruments.
- › **DO** arrange instruments made of different metals (stainless steel, tempered steel, aluminum, etc.) on different trays or keep them well separated from each other.
- › **DO** arrange receptacles upside down to prevent water from pooling inside.
- › **DO** ensure objects on trays are always arranged with some distance between them ensuring they will remain in the same position for the entire sterilisation cycle.
- › **DO** ensure that hinged instruments are sterilised in an open position.
- › **DO** position cutting instruments (scissors, scalpels, etc.) so that they do not come into contact with each other during sterilisation.
- › **DON'T** load the trays beyond their maximum indicated limit. (See STAT/M B Load Capacities chart at the start of Section 4. Loading Instruments).

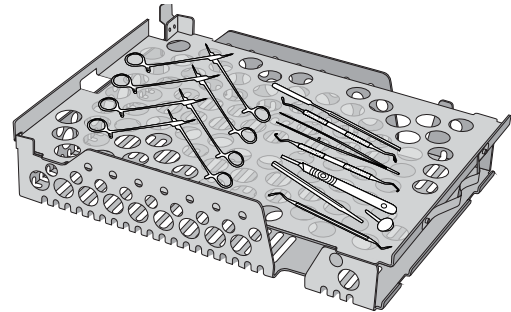

4.4 Rubber and Plastic

The following materials CAN be sterilised in the STATIM B:

Nylon, polycarbonate (Lexan™), polypropylene, PTFE (Teflon™), acetal (Delrin™), polysulfone (Udel™), polyetherimide (Ultem™), silicone rubber, and polyester.

When loading rubber and plastic tubing on the tray:

- › **DO** arrange receptacles upside down to prevent water from pooling inside.
- › **DO** process dental impression trays on the top tray to optimize drying.
- › **DO** process on the top tray any items with shapes that could collect water.

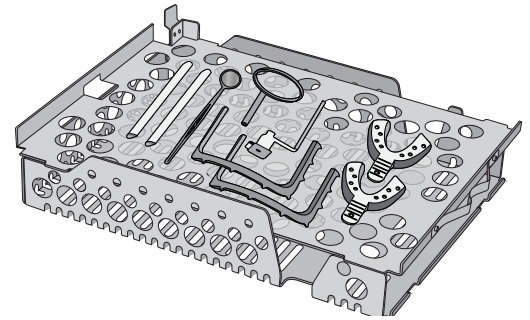

CAUTION! The following materials CANNOT be sterilised in the STATIM B:

Polyethylene, ABS, styrene, cellulose, PVC, Acrylic (Plexiglas™), PPO (Noryl™), latex, neoprene, and similar materials.

4.5 Using Biological and Chemical Indicators

Use chemical process monitors suitable for autoclaves/steam sterilisers at the indicated cycle temperatures and times in or on each package or load being sterilised. For biological indicator usage and frequency, follow the indicator manufacturer's instructions and your local regulations, guidelines and standards.

Note for Ophthalmology Use

In the field of ophthalmology, proper wrapping or pouching of surgical instruments will reduce the exposure of instruments to any process residues during the sterilisation cycle. Due to the highly sensitive nature of some types of surgery (particularly in ophthalmology), we recommend that all instruments be routinely packaged or wrapped and processed through the wrapped cycle of the steriliser. This practice is the suggested approach for the majority of sterile surgical procedures and is referenced in most leading infection control publications and guidelines.

5. Using Your STATIM B

5.1 Running a Cycle

1. Power on the unit.
The main switch is located on the back left of the unit.

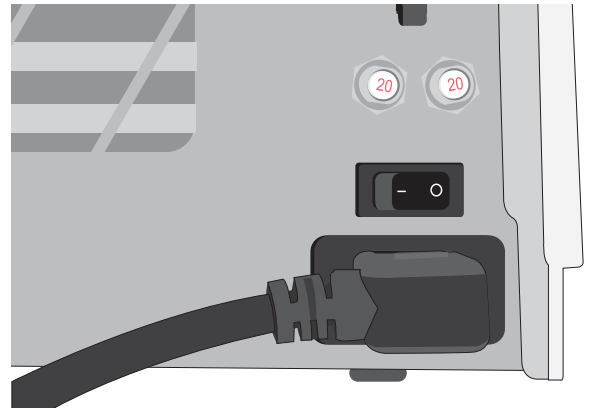

2. Ensure the reservoir is full.
You will not be able to start a cycle if the reservoir water level is below the minimum fill line.

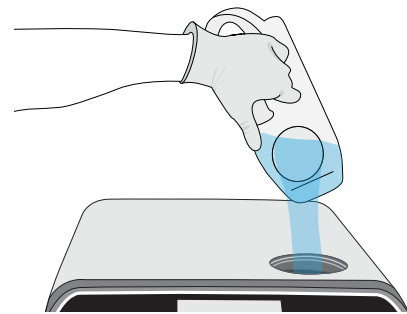

3. Open the drawer.
The LCD should display the **UNLOCKED** icon. Turn the latch and pull the drawer open. If the drawer will not open, press the **LOCK** icon to unlock.

CAUTION! Drawer and tray may be hot.

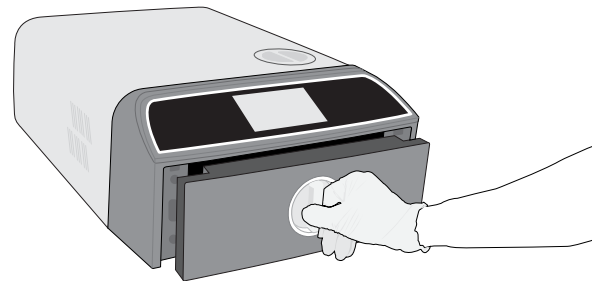

4. Load the instruments.
Refer to Section 4. Loading Instruments for detailed instructions.

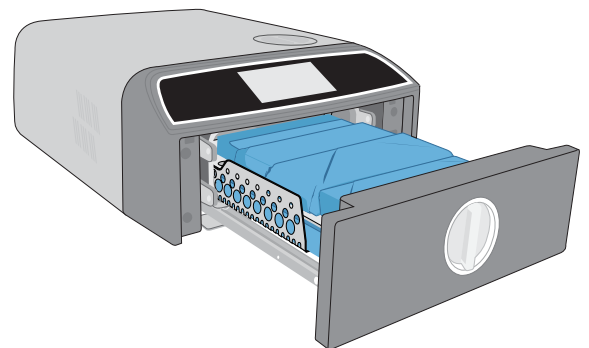

5. Close the drawer.
Push the drawer closed and turn the latch.

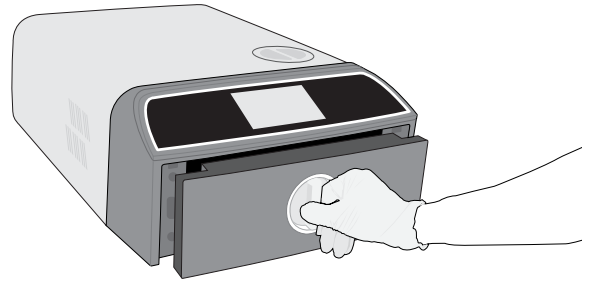

6. Select the cycle.
From the LCD, select the cycle you want to run (to learn more about the available cycles, see *Section 6. Sterilisation Cycles*). Then press the icon below it with the cycle time you want.

TIP

If User PIN ID has been enabled, you will be prompted to enter your User ID and PIN before your cycle selection is accepted.

If there is a problem with the drawer lock or water, a PRECYCLE SCREEN will appear.



7. Press the **START** button.
Select the drying button on the left to increase the drying time.
If the chamber is cold, warming up can take up to 5 minutes.
Allow the cycle to run to completion.



8. Cycle is complete.
When the cycle is complete, press the **STOP** icon to unlock the drawer.

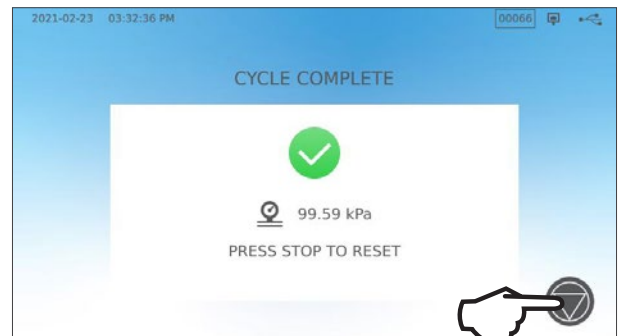

9. Remove the load.
Open the drawer. Clip the two tray extractors into the large holes on either side of the trays and lift the load from the drawer.

CAUTION! The metal parts will be hot.

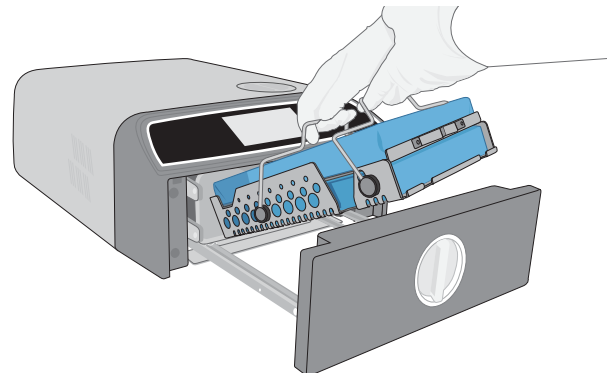

5.2 Stopping a Cycle

1. To stop a cycle BEFORE sterilisation is complete, press **STOP** on the touchscreen.

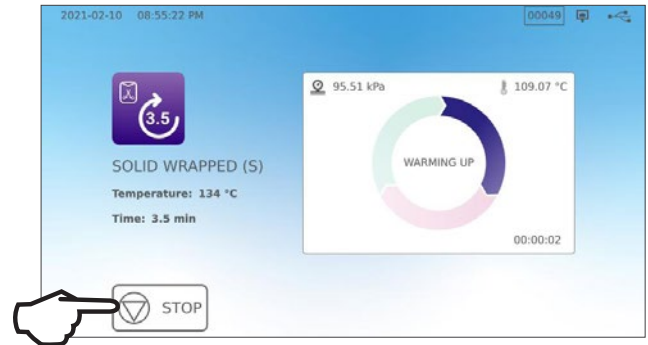

2. If you stop the cycle before sterilisation is complete, the unit will remind you that the load is NOT STERILE.

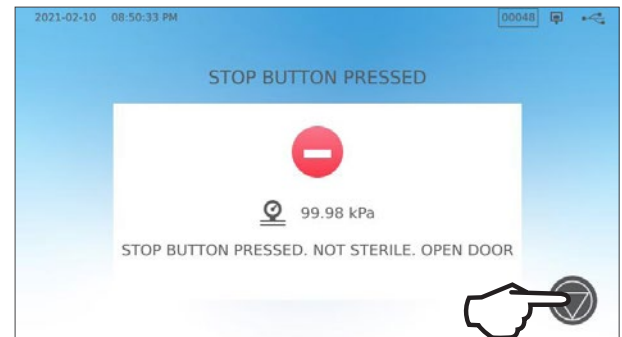

3. Press the **STOP** icon to continue to the home screen.

To stop a cycle **DURING** the drying phase, press the **STOP** icon at the bottom right of the touch screen.

1. If you stop the load during the drying phase, the unit will remind you to **CHECK FOR DRYNESS**.
2. Press the **STOP** icon to continue.

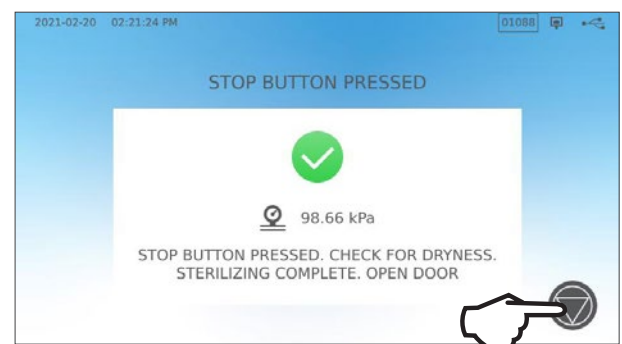

Opening the drawer after pressing STOP

Once a cycle has been stopped, the **STOP** button must be pressed before another cycle can be started.

To start a new cycle or to open the drawer:

1. Press the **STOP** icon to continue.

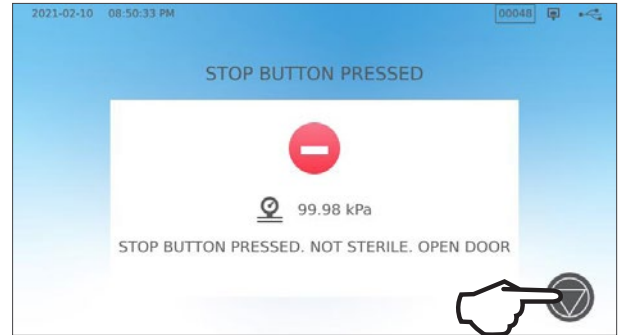

2. Press the **LOCK** icon.

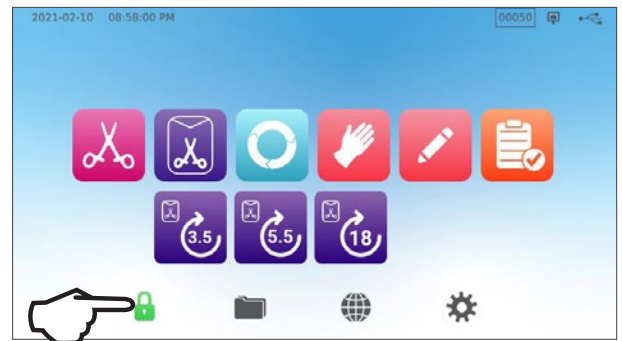

5.3 Using the Delayed Start

Select any cycle to access the START screen.

1. Press the **DELAYED START** button.



2. From here, you can enter a **SPECIFIC TIME** you would like the unit to start and then press the **DELAYED START** button to begin the countdown.

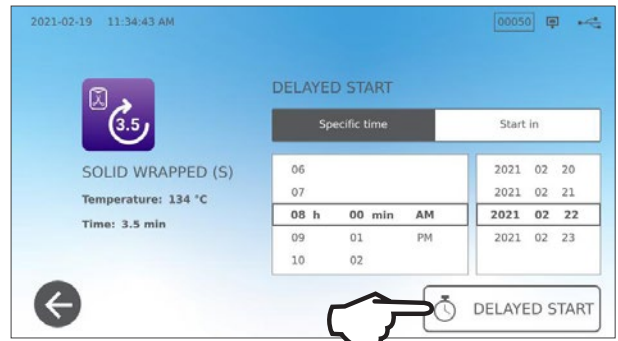

3. Or you can press **START IN** to use the countdown function.



4. The LCD will remain on the delayed start screen - showing either the countdown or the delayed start time - until the cycle begins. Press the **STOP** button if you want to change or reset the scheduled start time. Press **START NOW** if you want to override the delayed start and begin the cycle immediately.

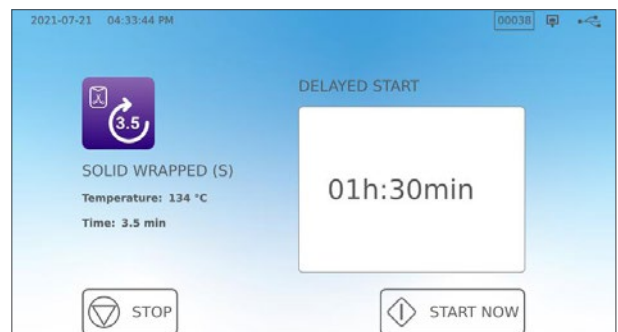
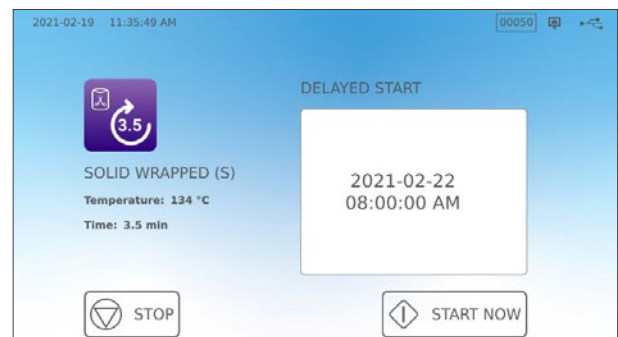

5.4 Emergency Drawer Opening

The STAT/M B is equipped with a safety mechanism that keeps the chamber locked when the unit loses power during a cycle.

To unlock the drawer without power, follow these steps:

1. Wearing heat-resistant gloves, pull up on the pressure relief valve ring at the back right of the unit to exhaust steam from the chamber. Hold the ring open until there is no more steam coming out of the valve.

CAUTION! HOT STEAM POSSIBLE

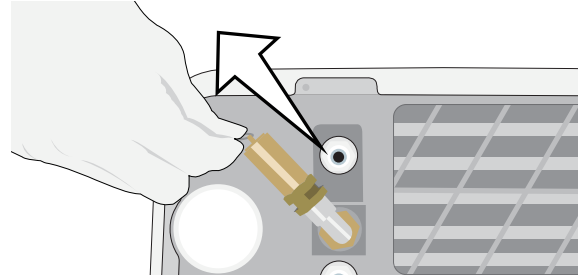

2. Lift the front of the unit with your left hand on the drawer latch and your right hand under the right front corner.

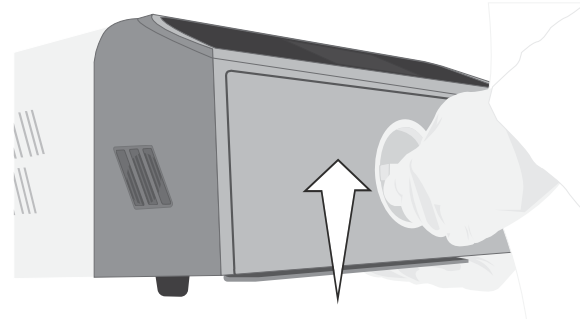

3. Reach under the front right of the unit for the metal tab and pull it forward while your left hand turns the drawer latch and pulls the drawer open.

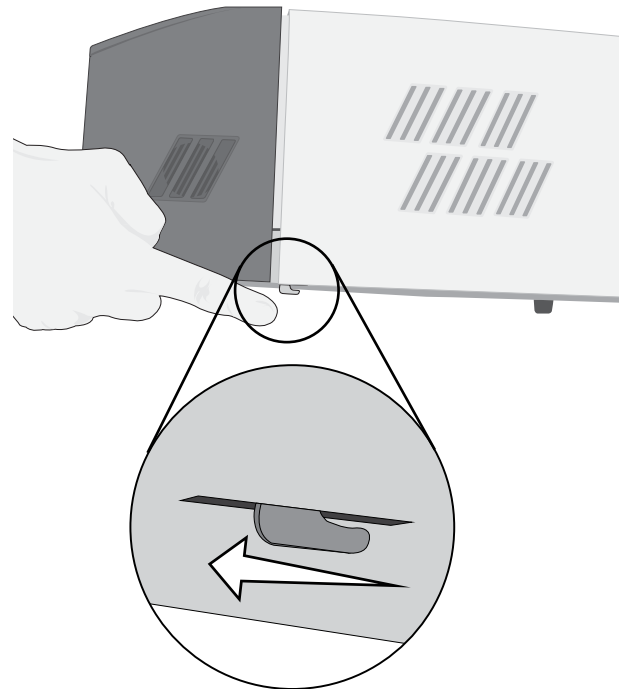

5.5 Running a Vacuum Test

The vacuum test checks the autoclave's plumbing system for leaks and should be done on a regular basis in accordance to your local guidelines. Run this test with the empty trays in the chamber. Test should be done on a cold chamber. If the chamber is hot, turn OFF the unit (or turn off the stand-by mode) and let the drawer cool.

1. From the home screen, select the **TESTS** icon.
2. To run a vacuum test, press the **V** icon.

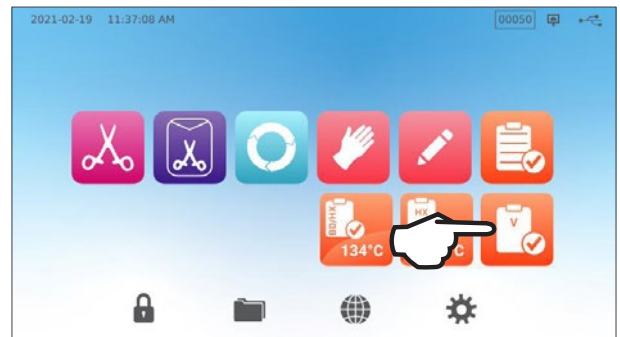

3. Press **START NOW**.

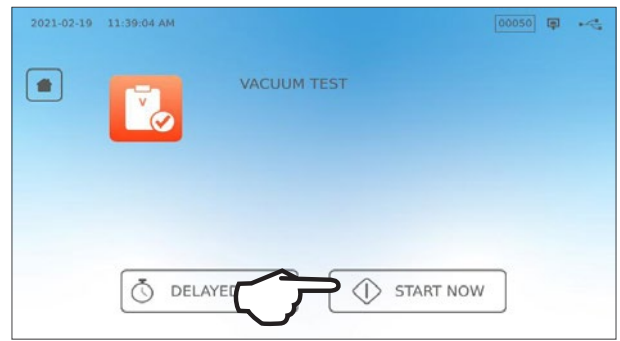

Running a vacuum test can take a minimum of 15 minutes. When the test is complete, the screen will display a CYCLE COMPLETE message. If the test has failed, see *Section 11. Troubleshooting*.

Presetting your vacuum test

To schedule a vacuum test before the start of the next working day, use the delayed start function.

1. When you have finished using your steriliser for the day, select the **Vacuum Test** icon.

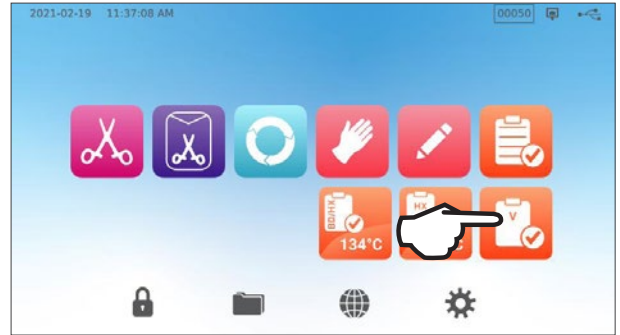

2. Press the **DELAYED START** button.

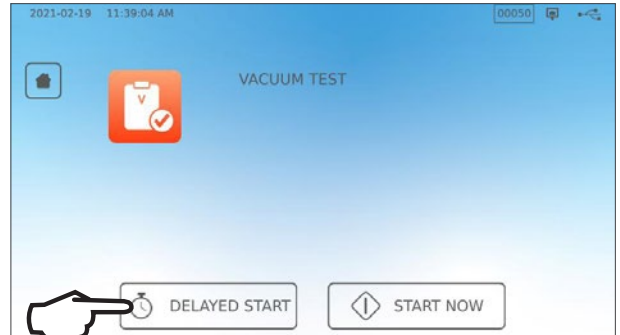

3. Press **SPECIFIC TIME** to schedule a time and date for the unit to start the test. Or **START IN** to use the countdown timer.
4. Press the **DELAYED START** button.

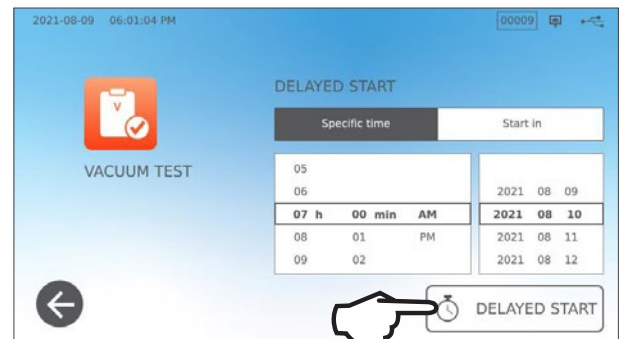

5. Press the **BACK** icon to reset countdown. The LCD will remain in the delayed start mode until the cycle begins.

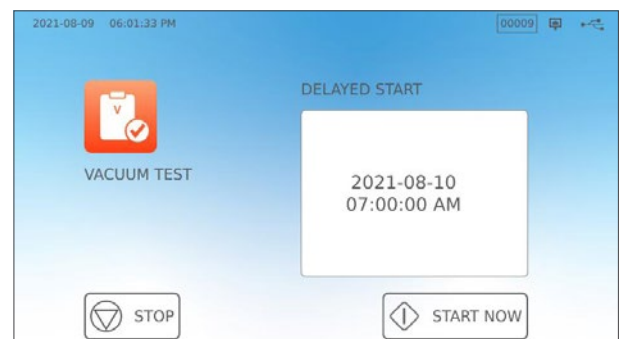

5.6 Running a Bowie-Dick/Helix 134°C Test

Bowie-Dick and Helix tests are used to ensure proper air removal is occurring in a pre-vacuum autoclave. Complete air removal is important because pockets of cool air remaining in the chamber can compromise sterilisation. The Bowie-Dick/Helix 134°C test runs a cycle at 134°C (273°F) for 3.5 minutes to evaluate the correct air removal.

To perform a Bowie-Dick/Helix 134°C test, you will need a Bowie-Dick or Helix device or test pack. These are NOT supplied with your STAT/M B. To perform the test, follow the instructions provided by the test pack manufacturer.

Generally, the process is as follows:

1. Open the drawer to insert a test pack. Position pack at the front on the lower tray.
2. Close and lock the drawer.

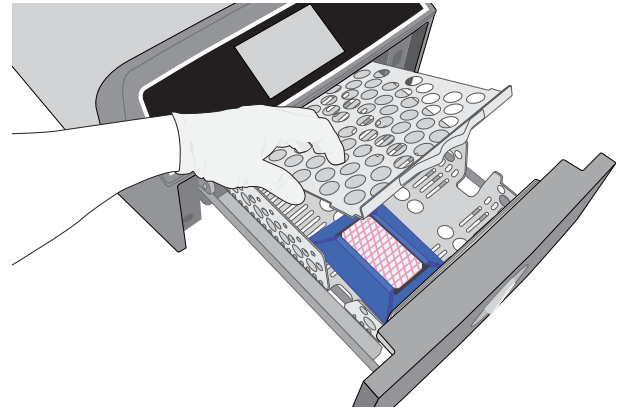

3. From the home screen, select the **TESTS** icon.

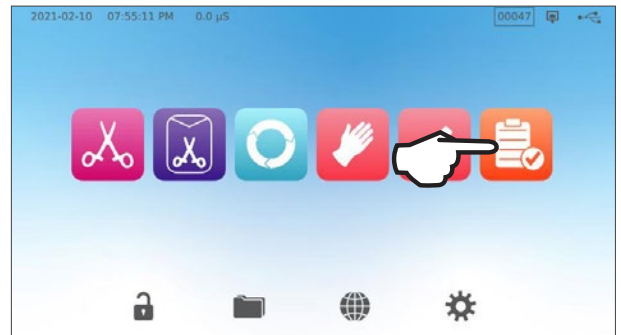

4. To run a Bowie-Dick or Helix 134°C test, press the **BD/HX 134°C** icon.



5. Press **START NOW** and allow the test to run to completion.

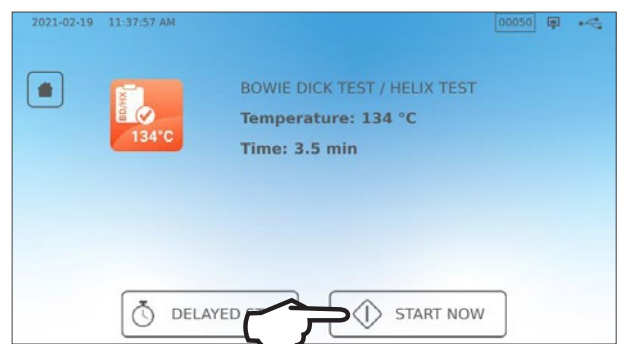

6. Press the **STOP** icon to open the drawer.
7. Follow the test manufacturer's instructions to interpret the test results.
8. If the unit passes the test, it is ready for use. If the unit fails, check the test manufacturer's instructions and repeat the test. If the second test fails, contact your service technician.

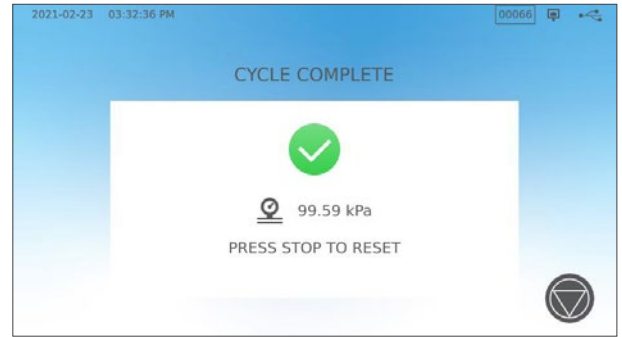

Presetting your Bowie-Dick/Helix 134°C Test

To schedule a Bowie-Dick/Helix test before the start of the next working day, use the delayed start function. The process is the same as described in the section above for the Vacuum test.

5.7 Running a Helix 121°C Test

To perform a Helix 121°C test, you will need a Helix device or test pack. These are NOT supplied with your STAT/MB. To perform the test, follow the instructions provided by the test pack manufacturer.

Generally, the process is as follows:

1. Open the drawer to insert a Helix test pack.
2. Close and lock the drawer.

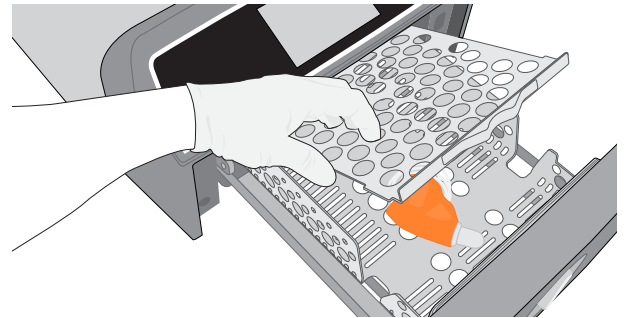

3. From the home screen, select the **TESTS** icon.
4. Select the **HX 121°C** icon.



5. Press **START NOW**.

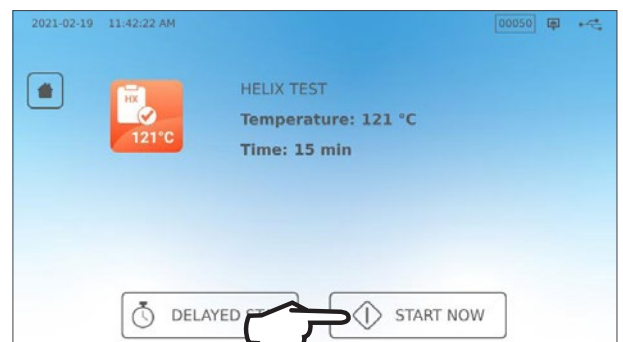

6. Press the **STOP** icon to open the drawer.
7. Follow the test manufacturer's instructions to interpret the test results.
8. If the unit passes the test, it is ready for use. If the unit fails, check the test manufacturer's instructions and repeat the test. If the second test fails, contact your service technician.

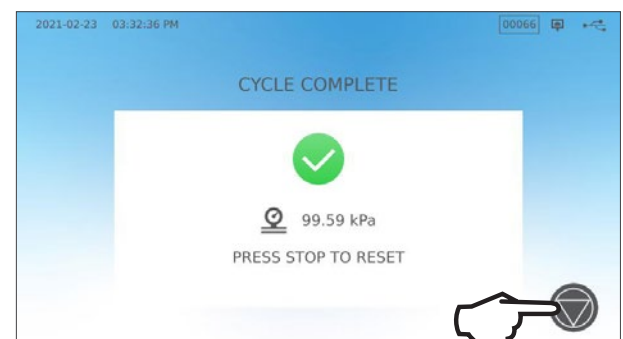

Presetting your Helix 121°C test

To schedule a Helix 121°C test before the start of the next working day, use the delayed start function. The process is the same as described in the section above for the Vacuum test.

5.8 Using the Custom Cycles

The custom cycles can be used to accommodate the sterilisation of instruments requiring cycles with parameters that are different from the unit's preset cycles. Users can define parameters for custom cycles according to the instrument manufacturer's instructions by choosing from a list of temperatures, sterilisation times and drying times to create up to two unique cycles that can be made accessible from the main menu.

CAUTION! Custom cycles have NOT been validated and have NOT been cleared by any regulatory authority. The user is responsible for validating the sterilisation efficacy of a custom cycle.

To adjust the settings of these cycles, select **SETTINGS** then **CYCLES** and follow these steps:

1. Select the **CUSTOM CYCLE** icon.

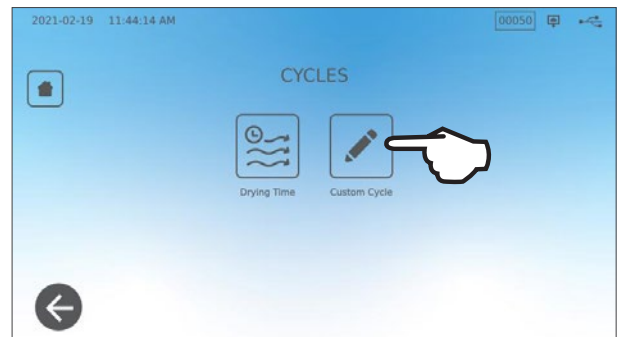

2. In the **Custom Cycle** menu, select the tab for the custom cycle you want to define (either Cycle 1 or Cycle 2).

Each custom cycle will allow you to select from pre-set options for cycle temperature, sterilisation time (how long the cycle will hold the sterilisation temperature), and drying time. When you have completed your selections, press the **CHECK MARK** to save your changes and exit.

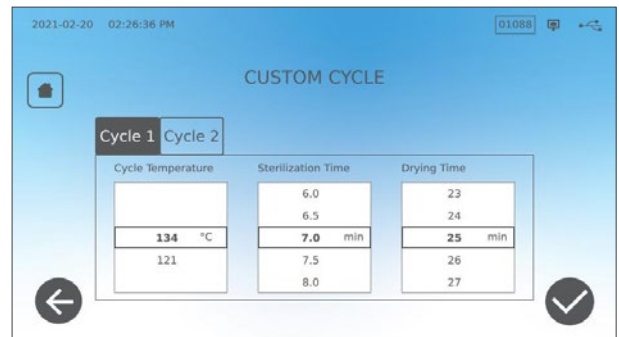

3. To confirm your changes, select the **CUSTOM CYCLE** icon from the home screen and select the custom cycle you created.

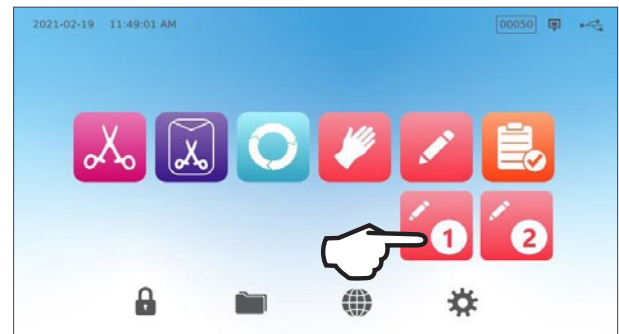

4. Check the cycle description at the top of the start screen to make sure it matches the cycle you created. If it is incorrect, return to the **Custom Cycle** settings and re-enter your selections.

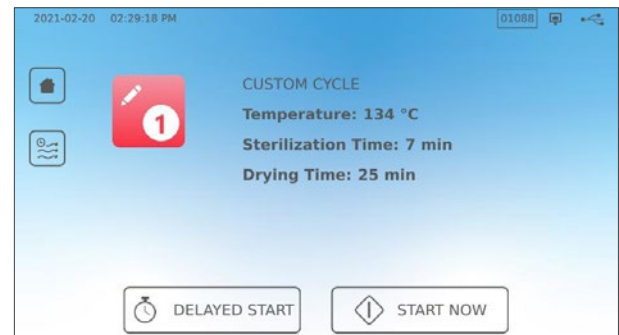









IMPORTANT! Each temperature option comes pre-set with a minimum sterilisation time and drying time. Follow the instrument manufacturer's instrument reprocessing instructions when setting time and temperature. Failure to do so could result in damage to the instruments and/or autoclave.

6. Sterilisation Cycles

The STATIM B features 11 validated sterilisation cycles with optimized drying for the fast, effective sterilisation of the various types of loads used in a medical or dental environment. Two additional custom cycles can be configured using two temperature settings but these cycles must be validated by the user.

The table below describes load types and corresponding sterilisation requirements. *Load size requirement details are listed in Section 4. Loading Instruments.*

NOTE: When selecting a sterilisation cycle, choose according to the load you are sterilising and the instrument manufacturer's reprocessing instructions.

Sterilisation CYCLE INFORMATION									
Cycle	Icon	Cycle Type	Temp. (°C)	Holding Time (min.)*	Standard Drying (min.) **	Total Cycle Time (load max.) Hot Start	Total Cycle Time (load max.) Cold Start	Description	Max. Total Mass (kg)
Solid / Unwrapped*		N	134	3.5	1	15	17	Immediate use cycle for unwrapped solid instruments (mirrors, explorers), hinged instruments (haemostats) on trays.	1.0
				5.5		17	19		
				18		29.5	32		
Solid / Wrapped		S	134	3.5	11	27	29	Single wrapped IMS cassettes with solid instruments. Rigid sterilisation containers with solid instruments. Single-pouched solid instruments on a pouch rack.	2.6
				5.5		29	31		
				18		41.5	43		
Universal		B	134	3.5	11	27	29	Unwrapped solid and hollow instruments. Wrapped solid and hollow instruments. Wrapped cassettes. Textiles.	2.6
				5.5		29	31		
				18		41.5	43		
Rubber & Plastic		S	121	20	5	31	33	Unwrapped and wrapped solid or hollow instruments constructed of metal, rubber and plastic.	1.0
				30		41	43		
Custom †		-	134	3.5 - 18	-	-	-	For devices that require different cycle parameters than those available. Set according to the instrument manufacturer's instructions.	-
			121	20 - 30		-	-		
Hollow Unwrapped <i>(some regions only)</i>		S	134	3.5	1	15	17	Immediate use cycle for unwrapped hollow instruments, handpieces or lumen instruments on trays.	1.0
				5.5		17	19		
				18		29.5	32		
Hollow Wrapped <i>(some regions only)</i>		S	134	3.5	5	21	23	Single-pouched hollow instruments, handpieces or lumen instruments on a tray or pouch rack.	1.0
				5.5		23	25		
				18		35.5	37		
Helix/BD Test		-	134	3.5	-	12	14	Test device only (without another load).	-
			121	3.5		12	14		
Vacuum Test		-	-	-	-	-	-	Empty chamber.	-

*Holding time options available by pressing cycle icon on home screen

**Dependent on load, it may be necessary to adjust drying in the settings menu

† Custom cycles have NOT been validated and have NOT been cleared by any regulatory authority. The user is responsible for validating the sterilisation efficacy of a custom cycle. The parameters for custom cycles are to be set according to the instrument manufacturers' instructions for use for devices that require different sterilisation times and temperatures that are not already available.

7. Using and Changing Settings

The STAT/M B features several settings that can be adjusted. The chart below provides an overview of where these settings can be found within the menu structure and tells you what you can do with each button. Functions such as setting up load traceability, user names and passwords, setting drying times and stand-by mode are explained in more detail later in this chapter.



SETTINGS BUTTON	SUBMENU BUTTON	WHAT TO DO WITH IT
Time and Date		Enter values or set automatically.
Language and Units		Select from a list of languages Select Celsius or Fahrenheit Select country Select time zone
System	Display	Set screensaver delay Set theme (light or dark) Set LCD brightness
	Sound	Set button beep on/off Set button beep volume
	Stand-by Mode	Set when the chamber stays warm Set chamber stand-by heating to high, low, or off
	Intro Setup	Use to initiate the Intro Setup Wizard
	Water Filling	Set to automatic if using an auto fill system
	Water Drainage	Drain water reservoir (manual or scheduled)
Network Setup		Set Internet connectivity
Process		Access enhanced record keeping functions for cycles
Cycles	Drying Time	Extend drying time on each cycle
	Custom Cycle	Set the temperature, duration and drying time for up to two custom cycles
Printer		Set printer type and adjust settings

7.1 Setting Up Load Traceability with User names, passwords, and Process Enforced Function

The Process Enforced function documents who has started and who has removed a load from your STAT/M B. It does this by prompting users to enter a user name and password at the start of a cycle, when they stop or cancel a cycle, and when they remove a load. Using Process Enforced does not restrict any functions, it is simply a means of tracking which of the registered users was operating the unit. To use the Process Enforced feature, you must first assign user names and passwords

To set up a user name and password, go to **SETTINGS** and follow these steps:



To turn Process Enforced usage **ON**, **OFF** or to activate **DOCUMENTATION** mode, select **SETTINGS** and follow these steps:

1. Scroll to **PROCESS** and select.
2. Use the side menu to select one of the following:

Standard: Process enforced is OFF.

Enforced: Process enforced is ON.

Documentation: Process enforced is ON and asks for additional load contents details.



Any user can stop a cycle and remove the load even with the Enforced or Documentation feature ON. However, the cycle data will record that an unregistered user has stopped the cycle and/or opened the drawer.

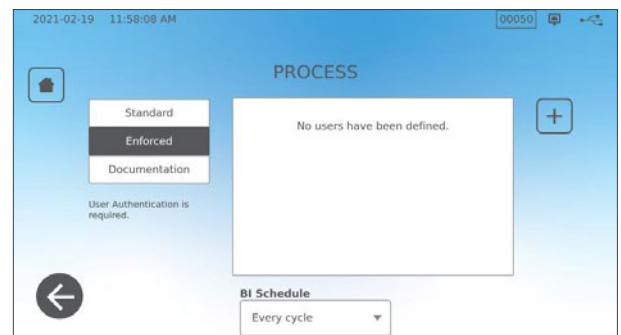

Using Documentation mode:

This mode activates the Process Enforced usage function along with the additional Documentation function that generates a report with information about the cycle and the load contents.

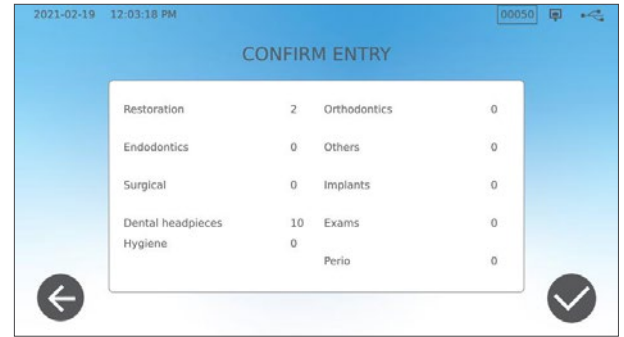
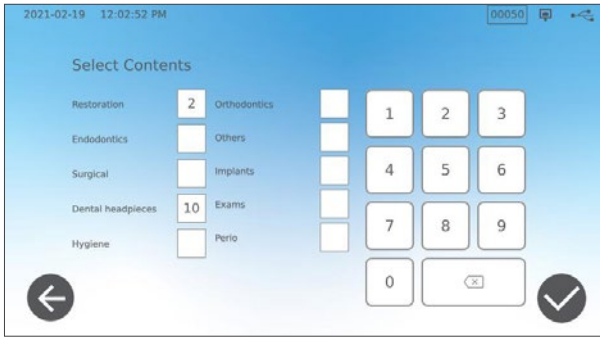

When starting a cycle with Documentation mode turned ON, you will be prompted to identify the general contents of the load to be processed by selecting from a list as well as whether a biological indicator and chemical indicator are included.

At the end of the cycle, you will be prompted to report whether the indicators have passed and whether the load is dry (as applicable).

Biological indicator/spore test results are available at a different time than chemical indicators but you still have the option to add the BI/spore test results to the documentation report when these results are available.

If the unit is connected to a label printer, you can select to print tracking labels for your biological indicator/spore tests.

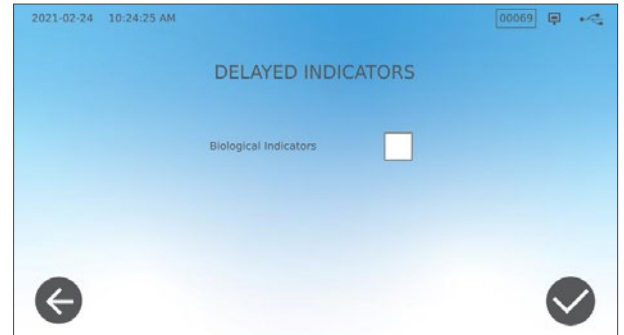

7.2 Setting Drying Time

The default drying times for each cycle are pre-set to provide optimal drying of a standard load. Use this function to reset the drying times on selected cycles if you feel the drying times are not sufficient for your loads. Loads must always be checked for dryness.

To change drying times, select **SETTINGS** then **CYCLES** and follow these steps:

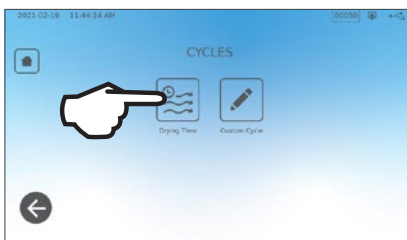

If you want to increase the drying time on a cycle just once, you can do so by pressing the DRYING button on the left of a cycle's start screen. Once the cycle is done, it will revert back to its default drying time.



7.3 Setting the Stand-By Mode

Using this setting will reduce the warm-up time between cycles by keeping the chamber at a temperature that is optimal for your office's level of use.

- › **STAND-BY LOW:** For low to average use. Provides a balance between keeping the chamber at 70°C (158°F) and using a minimum of electricity.
- › **STAND-BY HIGH:** For high use. Optimizes your STAT/M B for speed by keeping the chamber at 120°C (248°F).
- › **STAND-BY OFF:** For infrequent use. In this setting, the wait time will be longer (up to 12 minutes from a cold start). This is the unit's default setting.

To change this setting and to modify the amount of time the unit is in Stand-by, select **SETTINGS**, then **SYSTEM** and follow these steps:

1. Press stand-by mode.

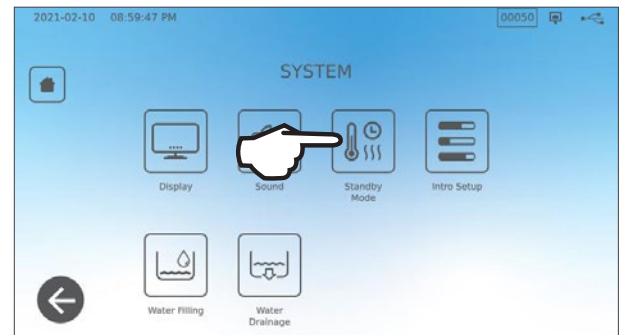

2. Select how warm you would like to keep the chamber (high, low or off) as well as a start and end time and which days of the week you would like the schedule to be active.

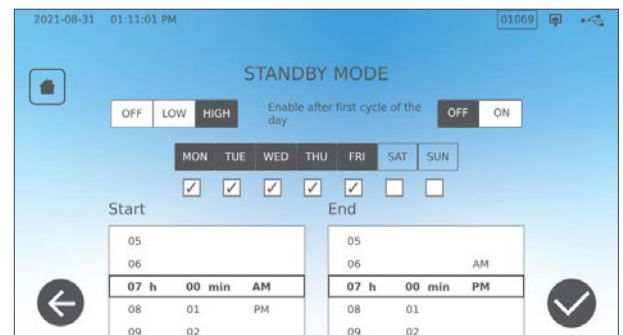

8. Storing, Retrieving and Printing Sterilisation Records

The STATIM B's internal memory can store data on every cycle, whether successful or incomplete, for the lifetime of the unit. You can access this information through the unit's LCD touchscreen, by exporting to a USB storage device or to an email address, or by connecting a printer. Coltene-SciCan also provides a cloud-based service that will automatically upload your unit's cycle data to an online storage service for safe off-site record keeping.

8.1 Retrieving Cycle Information Using the Touchscreen

To view complete cycle information on the screen, follow these steps:

1. Press the **FOLDER** icon on the **HOME** screen.



2. Select a cycle number from the list to see its details.

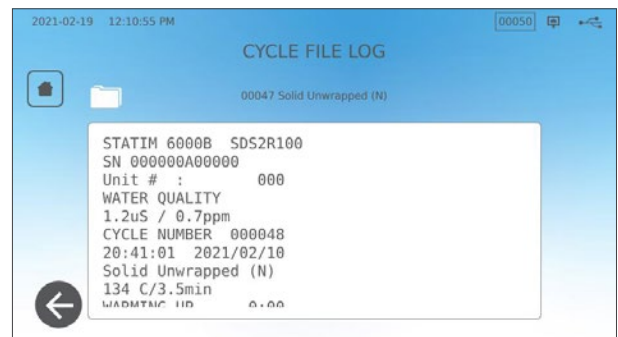
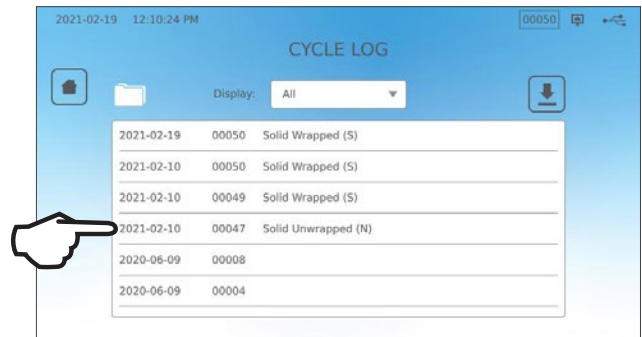

8.2 Exporting Cycle Information Using the Unit's USB or Email

You can use your unit's USB storage device or an email address to send cycle information stored in the unit to a computer. Best practice suggests this should be done once a week.

To transfer data using the USB port, follow these steps:

1. Insert the USB storage device into one of the unit's USB ports (front or back).



2. From the Cycle Log screen, press the **FOLDER** icon.

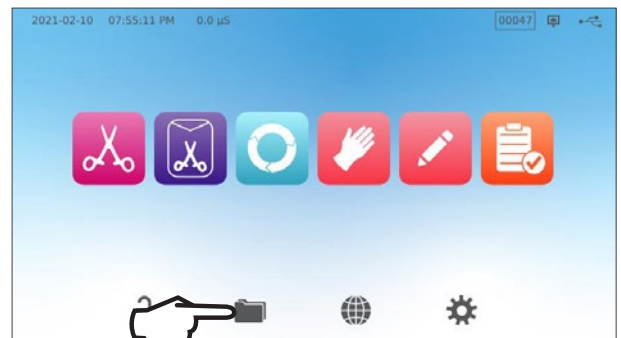

3. Press the **DOWNLOAD** icon.

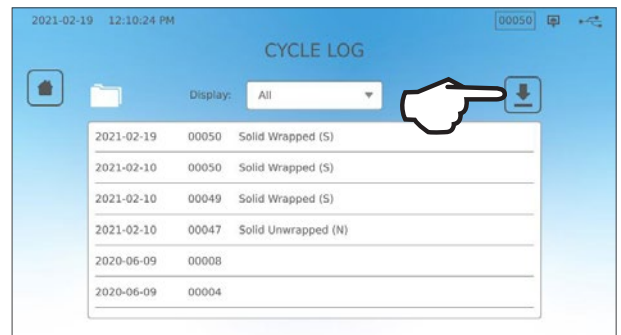

4. Select export to USB and press the **CHECK MARK**.
5. Select the number of record days to export. Then press the download symbol to start the export.

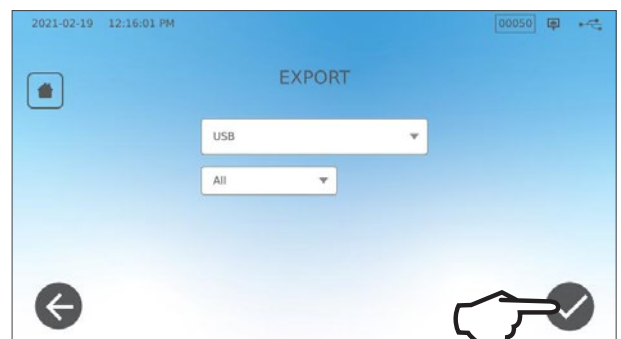

To transfer data to an email address, follow these steps:

1. From the **HOME** screen, press the **FOLDER** icon.



2. Press the **DOWNLOAD** icon.

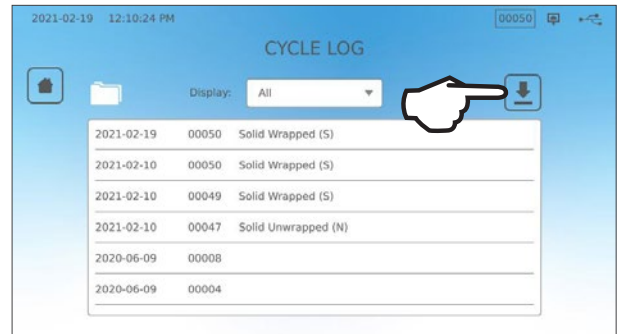

3. Select export to Email and press the **CHECK MARK**.

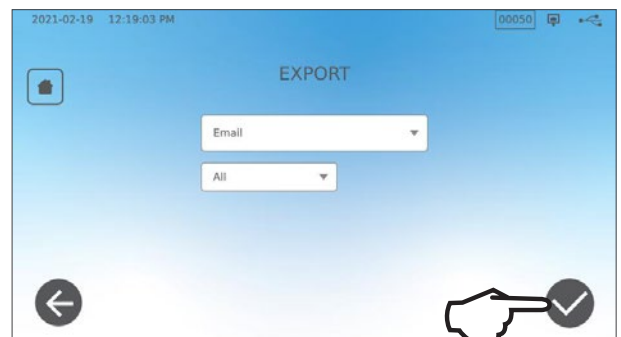

4. Enter an email address and press **NEXT** to start the export.



8.3 Connecting to Online Storage

To use the cloud service for storing your unit's cycle data, you will have to connect your unit to the Internet and register for online access using the unit's Setup Wizard. The Setup Wizard will prompt you to enter your account information to connect your unit to online record storage. If you do not have an account, the Setup Wizard will prompt you to enter an email to initiate the account set-up process.

The Setup Wizard starts automatically when a unit is powered on for the first time. You can also prompt your unit to run the Setup Wizard by selecting **SETTINGS** and following these steps:

1. Select **SYSTEM**.

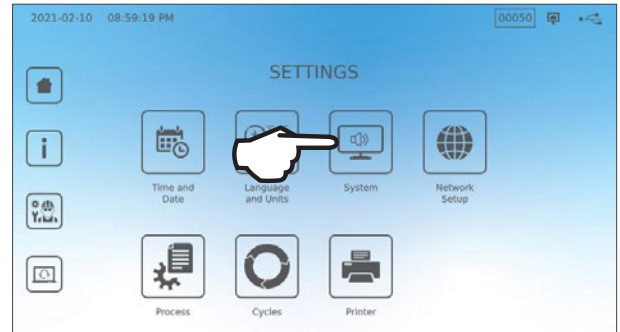

2. Select **INTRO SETUP**.

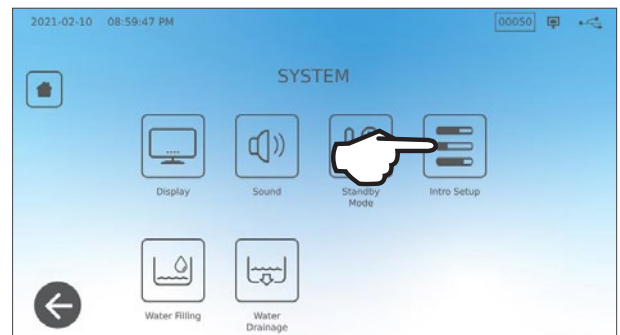

3. Follow the prompts through the Setup Wizard. When you arrive at the Online Account screen, select **YES** to enter your account information.

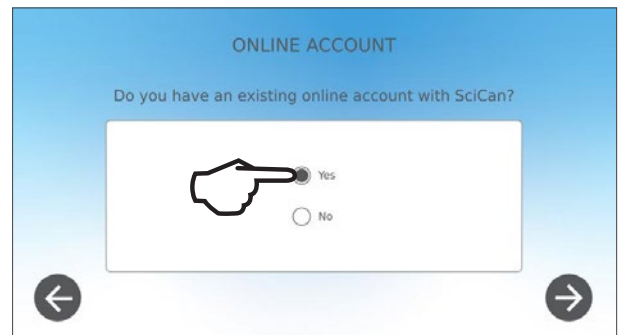

4. If **NO**, enter your email and initiate the account set-up process. Check your inbox for a registration email. (If you did not receive a confirmation email, check your spam folder.) Click on the link and follow the prompts to create your cloud service account or add your STATIM B to your existing account. When your account is active, you can log in to your account to access your unit's cycle history and warranty information.



8.4 Connecting to a Printer

Some users may prefer to have a printed record generated after every cycle. To use an external printer you must connect it to one of the unit's two USB ports at the back. Once the printer is connected, enabled and its settings correctly adjusted (see below), it will automatically print a record of each cycle.

NOTE: STAT/M B can connect to other G4-enabled units to use their printer(s).

To connect the printer, power on the printer and from the home screen, select **SETTINGS**, then **PRINTER**, and follow these steps:

1. Select **PRINTER**.
2. Select the printer type.
If using a network printer, select network printer and follow the prompts to connect it to an IP address.
3. If using a local printer, connect the printer to a USB port at back of unit.
4. Select the printer type from the drop down menu. Use the test page function to make sure it is connected and functioning correctly.

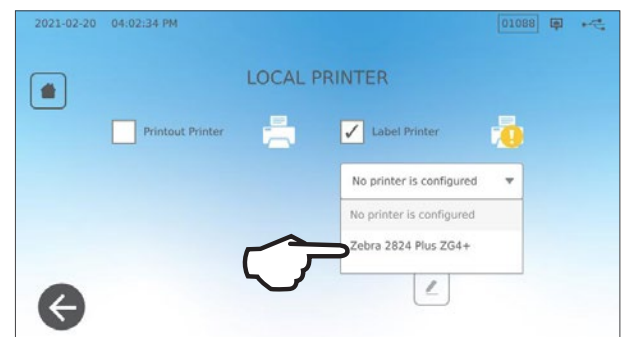
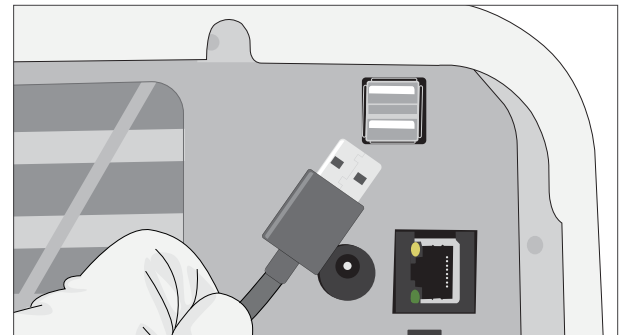
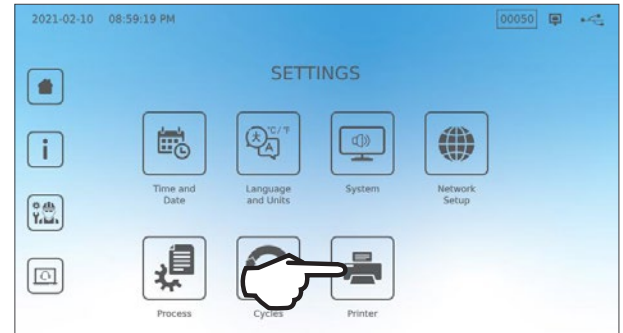

NOTE About Thermal Paper Records: Under normal storage conditions, a thermal document will remain legible for a minimum of 5 years. Normal storage conditions include avoiding direct sunlight, filing in office temperatures below 25 degrees Celsius and moderate humidity (45-65% relative humidity) and not next to incompatible materials including plastic, vinyl, hand lotion, oil, grease, alcohol-based products, carbonless paper and carbon paper.

8.5 Cycle Printout - Full Cycle

Model: STATIM 6000B	STATIM 6000B	SDS2R100	Software: Revision 100
Serial number: 310800A03600	SN 310800A03600		
Unit identifier: Autoclave has been set up as number 000	UNIT # :	000	
Quality of water in reservoir	WATER QUALITY 5.2uS / 3.3PPM		
Time/Date: 1:31 pm 15th December 2020	CYCLE NUMBER 13:31:12	000043 2020/12/15	Cycle counter: the number of cycles that were run on the unit is 43.
Cycle name and parameters: SOLID WRAPPED (S) for 134°C/3.5 minutes	Solid Wrapped (S) 134 C/3.5min		
Warm up complete: Start of the vacuum draw is 1:11	WARMING UP 111.7 C 101kPa	0:00	Cycle clock: starting at 0:00
	VACUUM DRAW 111.6 C 17kPa	1:11	Temp./Press. & Time printed at different intervals during the vacuum draw and pressure pulse phases
	PRESSURE PULSE 111.9 C 121kPa	1:23	
	VACUUM DRAW 111.2 C 29kPa	1:56	
	PRESSURE PULSE 112.5 C 121kPa	2:12	
	VACUUM DRAW 112.1 C 29kPa	2:48	
	PRESSURE PULSE 114.2 C 121kPa	3:05	
	STERILIZING 135.7 C 315kPa	5:47 5:47	Start time of sterilisation: 5:47 (start of 'D' phase)
	Min. steri. Values: 135.3 C 311kPa		Sterilisation parameters
	Max. steri. Values: 135.9 C 317kPa		
	VENTING 135.5 C 314kPa	9:17 9:17	Start time of venting: 9:17 (start of 'E' phase)
	DRYING START 117.2 C 79kPa	11:28	Start time of air drying: 11:28 (start of 'F' phase)
	CYCLE COMPLETE	21:34	Cycle completion time: 21:34
Digital signature of the unit	Digital Signature # 9E7726C95F4CDA91 12D2D6DCF5B8BC248 B9106A8FC7F49F08 365400FA91D368AF		

8.6 Cycle Printout - Stop Button Pressed

Model: STAT/M 6000B	STATIM 6000B	SDS2R100	Software: SDS2R100
Serial number: 310800A03600	SN 310800A03600		
Unit identifier: Autoclave has been set up as number 000	UNIT # :	000	
Quality of water in reservoir	WATER QUALITY		
	5.1uS / 3.2PPM		
	CYCLE NUMBER	000040	Cycle counter: the number of cycles having been run on the unit = 40
Time/Date: 12:27 pm 15th December 2020	12:27:05	2020/12/15	
Cycle name and parameters: SOLID UNWRAPPED (N) for 134°C/3.5 minutes	SOLID UNWRAPPED (N)		
	134 C/3.5min.		
	WARMING UP	0:00	Cycle clock: starting at 0:00
	100.8 C 102kPa		Temp and Press at the start of the cycle
Warm up complete: Start of the first vacuum draw is 1:11 (see cycle graph - 'A' phase complete, start of 'B' phase)	VACUUM DRAW	1:11	
	99.1 C 17kPa		
	PRESSURE PULSE	1:30	First pressure pulse: 1:30 (start of 'C' phase)
	109.0 C 120kPa		
	VACUUM DRAW	2:13	
	106.0 C 29kPa		
	PRESSURE PULSE	2:28	
	109.0 C 120kPa		
	VACUUM DRAW	3:10	
	110.5 C 30kPa		
	PRESSURE PULSE	3:26	
	113.3 C 121kPa		
	CYCLE ABORTED	3:36	Cycle aborted at 3:36
Reason cycle was aborted	STOP BUTTON PRESSED		
	NOT STERILE		
	END TIME	3:36	
Digital signature of the unit	Digital Signature #		
	B83AAEE17C3182E3		
	C2E5D68DCEDF23E4		
	6356E3B77A276BFD		
	0545AFA4F4C52434		

Acceptable Tolerances*:

Sterilisation time: "Sterilisation time" (e.g. 3.5 mins) -0/+1%

Saturated Steam Pressure: 304kPa - 341kPa for Unwrapped/Wrapped cycle (205kPa - 232kPa for Rubber and Plastic cycle)

Sterilisation Temperature: "Specified temp" -0/+4 (134°C-138°C) (121°C -125°C for Rubber and Plastics cycle)

*data on Cycle Printout should fall within these ranges

9. Maintenance Procedures

Regular maintenance will ensure the safe and efficient operation of your STATIM B. Before performing any of the cleaning and maintenance procedures described in this chapter, power OFF the unit and disconnect it from its power source.

CAUTION! HOT SURFACES

- › **DO** always use our replacement parts.
- › **DON'T** use abrasive cloths, metal brushes or metal-cleaning products, whether solids or liquids, to clean the device or sterilisation chamber.

9.1 Preventative Maintenance Message

Frequency: As a default setting, this message will appear every 6 months or 1,000 cycles but it can be customized to better suit the needs of your clinic. You can also set up email notifications.

When a maintenance message appears, you have 2 options:

OPTION 1: OK

Press **OK** to clear the message. You can continue to use your STATIM B or perform the required maintenance. When you press **OK**, the maintenance notification counter will restart, regardless of whether or not you have performed the maintenance.

OPTION 2: REMIND LATER

If you press **REMIND LATER**, the message will repeat 24 hours later.

9.2 Preventative Maintenance Schedule

What you should do	
Daily	Wipe the drawer seal
	Clean external surfaces
	For ophthalmic use, drain the reservoir after each working day, leave empty, and refill at the start of the next workday.
Weekly	Clean the chamber and trays
	Drain water reservoir
	Disinfect external surfaces
	Clean chamber filter
Monthly or every 160 cycles (whichever is first)	Inspect the water reservoir filter (clean or replace)
	Clean the external fill water tank
	Clean the water reservoir filter
Every 6 months or 1,000 cycles (whichever is first)	Perform all monthly cleaning tasks
	Replace bacteriological air filter
	Replace drawer seal
What the technician should do	
Every 2 years or 2,000 cycles (whichever is first)	A complete maintenance of the autoclave including testing of the pressure relief valve and the power failure mode (by a qualified technician) is recommended.

9.3 Cleaning and Disinfecting the External Surfaces

Frequency: Clean daily. Disinfect weekly.

Clean and disinfect all of the STAT/M B's external parts using OPT/M® wipes or a clean, lint-free cloth dampened with water and, if needed, a mild detergent.

Dry the surfaces and remove any residue before powering ON the unit.

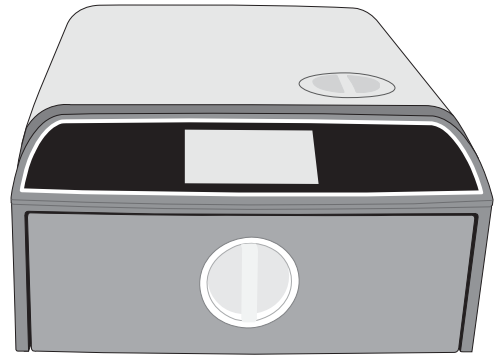

9.4 Cleaning the Chamber and Trays

Frequency: Weekly

Remove the sterilisation trays from the drawer.

Use a clean, lint-free cloth dampened with water to clean the chamber, drawer and the chamber flange. Wipe dry.

Use a clean, lint-free cloth dampened with water to clean the trays. Wipe dry.

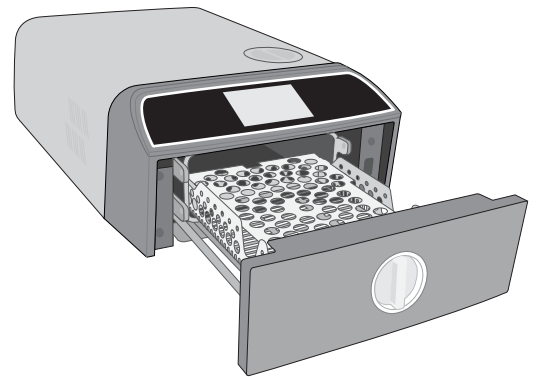

CAUTION! HOT SURFACES.

9.5 Cleaning the Chamber Filter

Frequency: Weekly

1. Turn the unit OFF and open the drawer to allow the chamber to cool.
2. Remove the trays.

CAUTION! HOT SURFACES



3. The chamber filter is located at the back left side of the chamber.

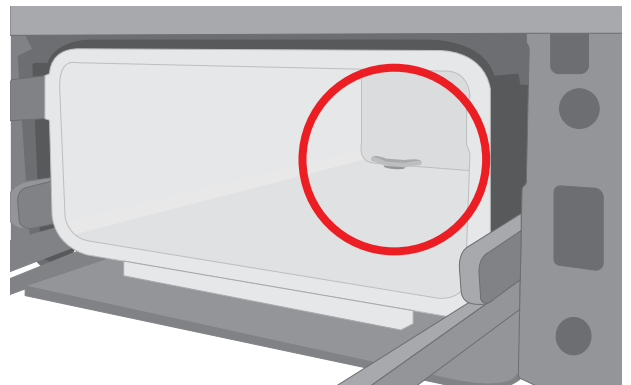

4. Pinch the two wings of the filter together and pull the filter out.

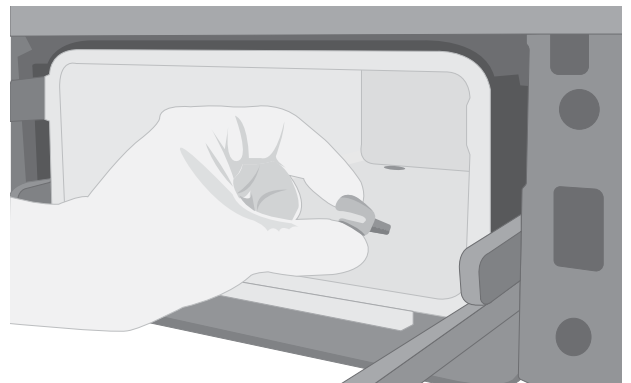

5. Rinse the filter and reinstall it by pushing it back into place.

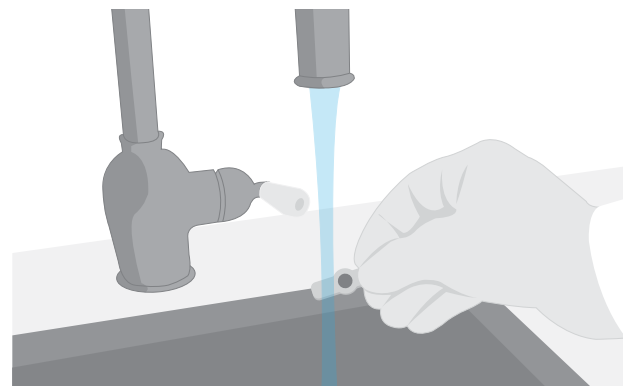

9.6 Draining the Water Reservoir

Frequency: Weekly, or Daily for ophthalmic use

To reduce the build up of bio film and other adverse water reservoir conditions, drain the water reservoir at the end of the work week, or at the end of every workday for ophthalmic use.

From the home screen, select **SETTINGS** and follow these steps:

1. Select **SYSTEM**.

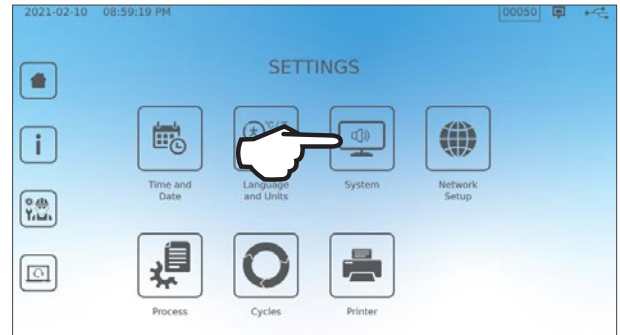

2. Select **WATER DRAINAGE**.

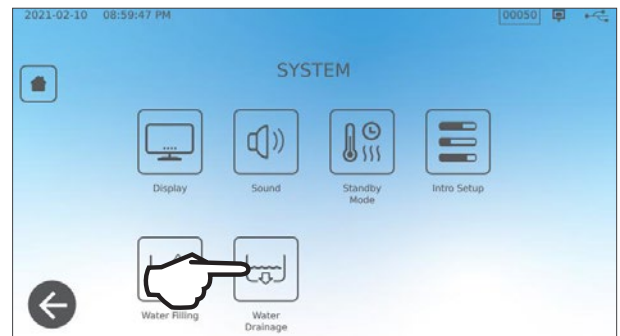

3. Press **START NOW** or schedule a time for the reservoir to be drained later automatically.

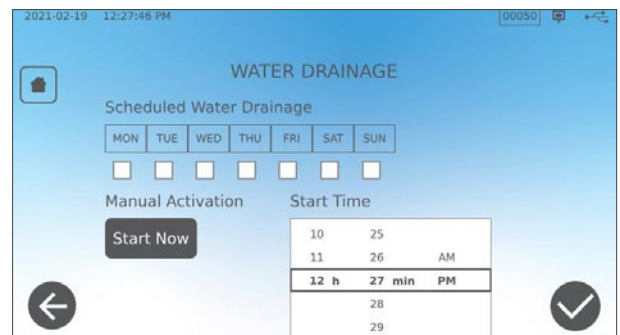

9.7 Cleaning the Water Reservoir Filter

Frequency: Monthly or every 160 cycles (whichever is first)

1. Remove the reservoir lid and remove the filter.
2. Clean it under running water.
3. Pat it dry and reinstall it.

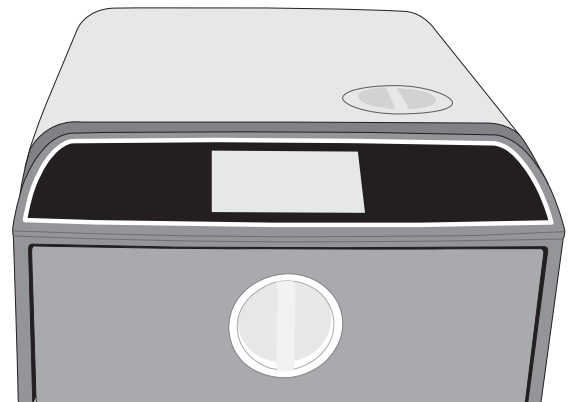

9.8 Cleaning an External Water Fill Tank

Frequency: Monthly or every 160 cycles (whichever is first)

1. Drain the external fill tank.
2. Fill the tank with a solution of distilled water and alcohol (10%).
3. Let the solution sit for 30 minutes.
4. Drain the tank and discard the solution.

9.9 Replacing the Bacteriological Air Filter

Frequency: Every 6 months or 1,000 cycles (whichever is first)

1. Access the back of the unit.

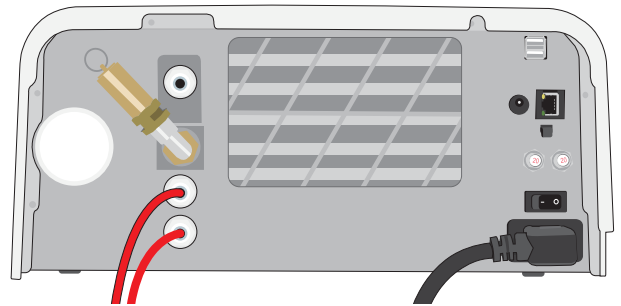

2. Unscrew the bacteriological air filter.

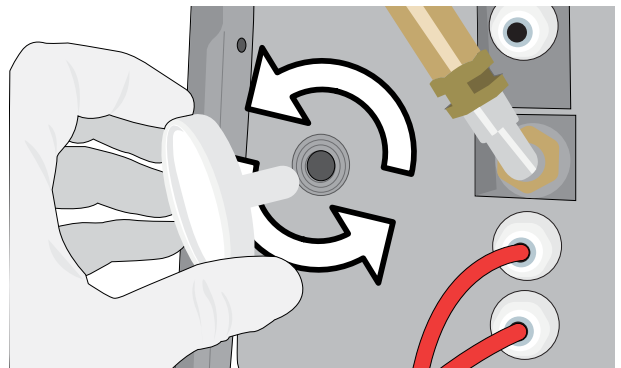

3. Replace it with a new filter.
Tighten by hand only.

CAUTION! A bacteriological filter must always be in place during a cycle. Running a cycle without a bacteriological filter in place will compromise the sterility of the load.

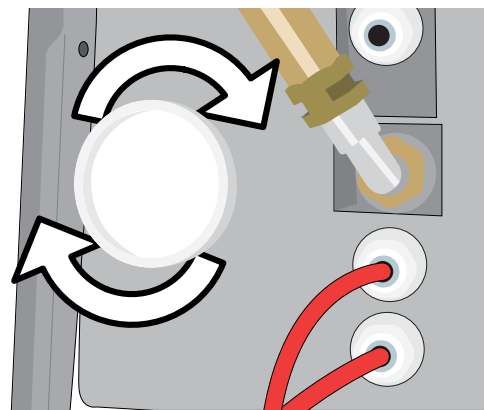

9.10 Replacing the Drawer Seal

Frequency: Every 6 months or 1,000 cycles (whichever is first)

1. Open the drawer and unhook the tray to slide it into the chamber and out of the way.

CAUTION! HOT SURFACES

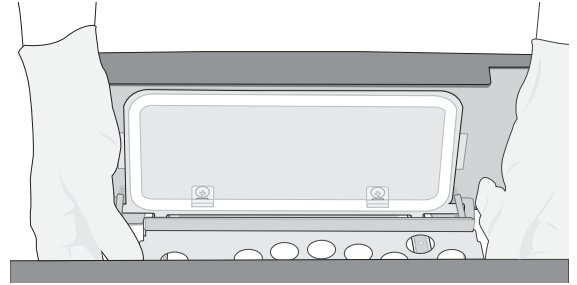

2. Remove the old seal by pulling it out of position. Clean the drawer seal channel of any debris.

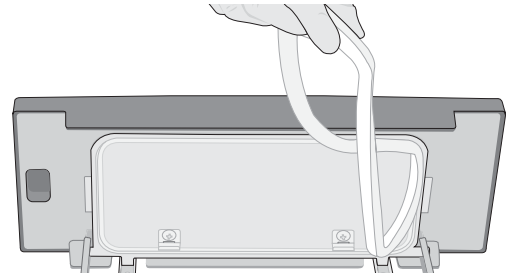

3. Put the new seal in place and start by pressing it into each corner. You can wet the seal with water to ease installation.

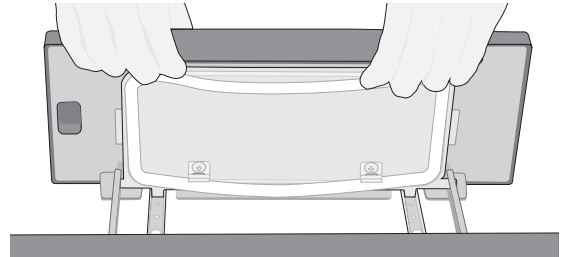

4. Then work from the corners inwards to seat the seal into the seal channel.

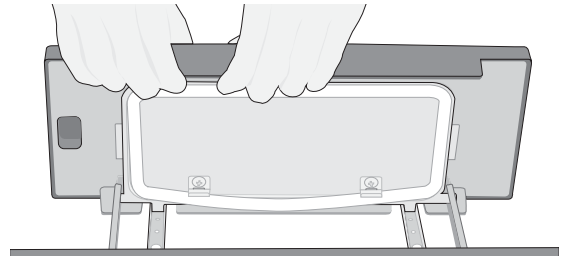

9.11 Accessing Video Instructions

The STATIM B has a number of maintenance and set up videos to help users learn to care for the steriliser. These instructions can be found in the **SETTINGS** menu.

1. From the home screen, select **SETTINGS**.

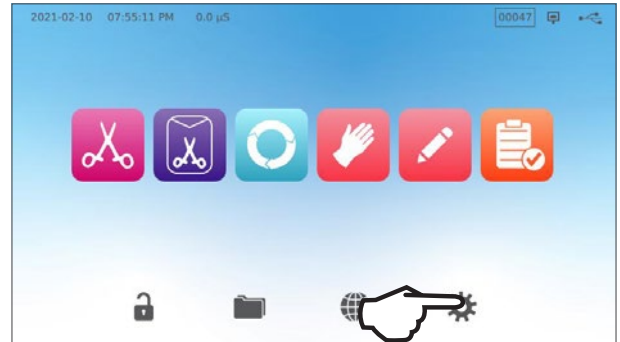

2. Press the **INFORMATION** icon.

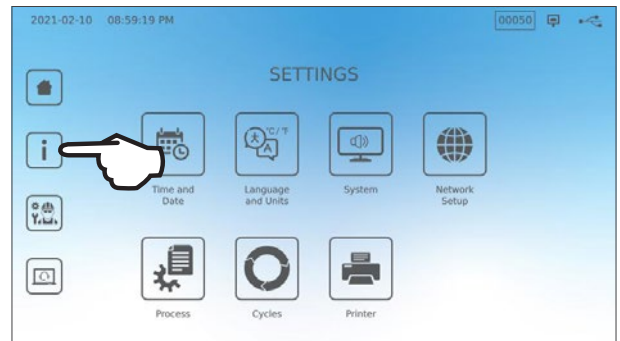

3. Press **INSTRUCTIONS**.

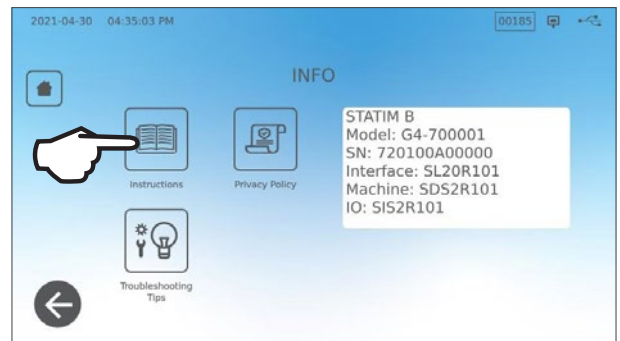

4. Select the video instructions you would like to view.

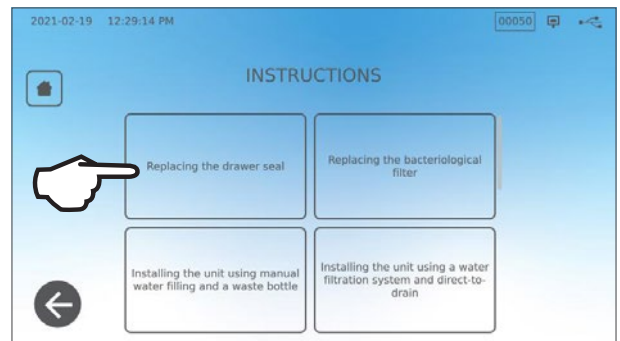

5. Press the **X** to stop the video.



9.12 Enabling Remote Access for a Technician

Technicians and other authorized personnel may want to connect to your STAT/M B from a remote location to review its functioning or access stored information. To allow an external user to remotely access your STAT/M B, you will need to provide a security token to the person requesting access.

To obtain this code, from the home screen, select **SETTINGS**.

1. Select the **REMOTE ACCESS** icon.

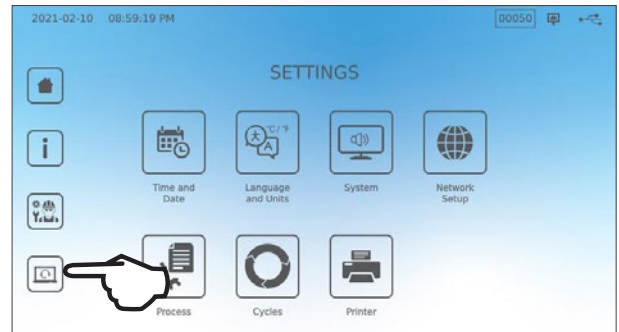

2. Press **ENABLE** to generate a code.

Note: The code is case sensitive.

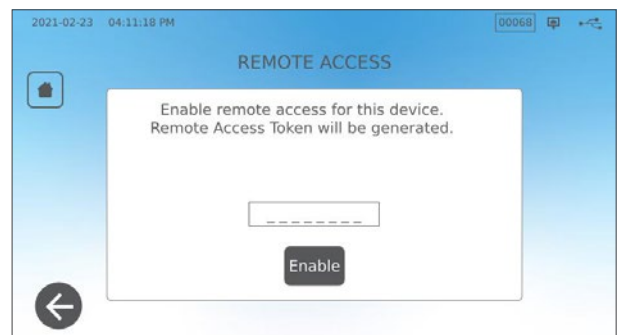

3. A pink frame will appear around the screen when it has been enabled for remote access. Press **DISABLE** when the session is completed.

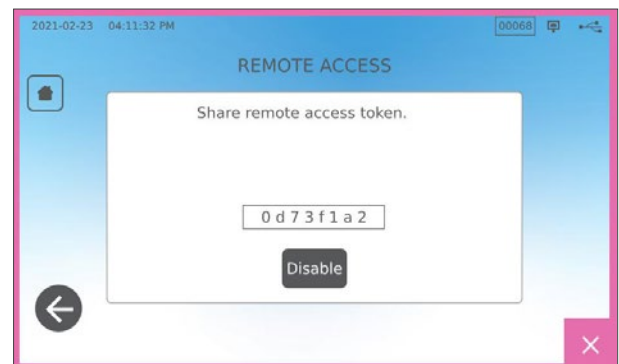

9.13 Preparing the Unit for Shipping

Drain the water reservoir

From the home screen, select **SETTINGS** and follow these steps:

1. Select **SYSTEM**.
2. Select **WATER DRAINAGE**.
3. Press **START NOW**.

Disconnect the tubing

1. Pull the unit forward to access the back.
2. Press on the inner grey ring of the port to release the Teflon drain tube.

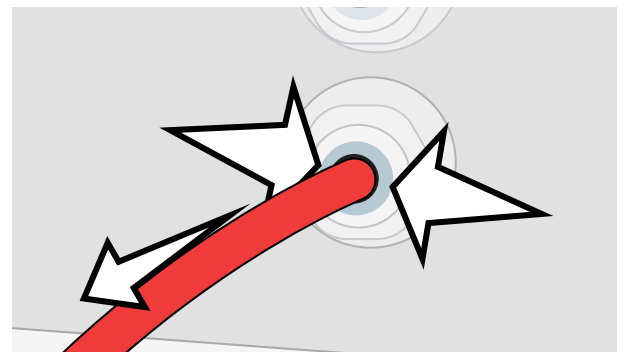

10. Troubleshooting

Problem	Possible Cause	What you can check before calling for service
No power.	Power cord or main power issue.	<p>Check that the unit is plugged into a properly grounded outlet and that the power cord is firmly seated at the rear of the machine.</p> <p>Try another outlet. Power the unit OFF for 10 seconds and then power it ON again.</p> <p>Check the condition of the line circuit breaker or fuse.</p>
There is water under the machine.	<p>Spill over from refilling.</p> <p>External water tank feed issue.</p>	<p>Check that water was not spilled when refilling the reservoir.</p> <p>Check that the tube coming from the external tank (if fitted) is completely pushed onto the connector.</p> <p>Check exhaust tubing connection.</p>
Cycle interrupted – NOT STERILE, Cycle aborted – NOT STERILE and CYCLE FAULT messages.	<p>The STOP button was pressed while the unit was in operation.</p> <p>A power outage or power fluctuation occurred while the unit was in operation.</p>	<p>Wait a few minutes and attempt another cycle.</p>
Excessive steam escaping from the front of the machine.	Drawer seal issue.	<p>Open and close the drawer then attempt another cycle. Check the seal for misalignment or damage. Replace the seal if required.</p> <p>If the leak persists, turn the unit OFF, remove the load and contact your dealer.</p>
The printer does not work.	Printer connection or power connection failure.	<p>Make sure that the printer cable is connected securely with the connector on the back of the unit. Make sure that the printer is powered ON. Power OFF the unit for 10 seconds and then power it ON again. Check printer settings.</p>
Time and date are incorrect.	Unit was shipped to a new time zone.	<p>The time and date are set on the date of manufacture but have not been adjusted for a new time zone. See <i>Section 7. Using and Changing Settings</i>.</p>
Touchscreen is blank/white.	Power was interrupted during a firmware upgrade.	Power OFF the unit and power it ON again.
Touchscreen is blank/ dark.	Power connection failure.	Check power source.
Red Xs next to Network and Internet on the Connectivity screen.	Unit is not connected to Internet.	<p>If it is supposed to be connected to a network and the X is visible, it is because the unit is unable to acquire an IP address.</p> <p>To resolve the issue, try some of the following:</p> <ul style="list-style-type: none"> › Check that the router is functioning properly. › Check the LAN cable (try a new cable if possible). › Make sure your router assigns IP addresses automatically. › Renew the IP address by following these steps: Press the network icon. Press IP setup. Press RENEW IP.

Problem	Possible Cause	What you can check before calling for service
Drawer will not open – no power.	Power failure.	Use the emergency drawer unlock procedure described in Section 5.
Drawer will not open - power OFF.	The warm unit cooled down overnight creating a vacuum that is holding the drawer closed.	Turn the unit ON and it will adjust the chamber pressure to allow the drawer to open.
Drawer will not open - power ON.	Lock status still engaged.	<p>The unit can be unlocked only when the lock icon is green</p> <p>The value of the chamber pressure is displayed at the top of the screen . When it is close to atmospheric and safe to open, the lock icon will turn green.</p> <p>Press the lock icon to unlock the drawer.</p> <p>If the lock icon remains red, try powering the unit OFF and ON to reset lock status.</p>
Water remains in the chamber at the end of a cycle.	Obstruction in the drain circuit or drain tube.	Check that the drain tube and drain port are not obstructed and that the drain tube runs freely from the device to the drain. Ensure that the waste water bottle is positioned below the unit.
Vacuum test has failed.		Attempt a second test. If it fails, contact your dealer.
Bowie-Dick or Helix test has failed.		Attempt a second test. If it fails, contact your dealer.
No cycles are stored in the unit's memory.	Logic board configuration issue.	<p>Check unit serial number to see if it was accurately updated after a logic board service. If the serial number consists of zeros, call your dealer.</p> <p>Remove the unit's USB and check it on your computer to see if the cycle records have been stored.</p>
Machine will not start, red X on Water Quality.	Water used is of inadequate quality.	<p>If the water quality is inadequate: You have likely used water that is not steam-process distilled or is improperly distilled.</p> <p>Empty the reservoir and refill with steam-process distilled water containing less than 6.4 ppm total dissolved solids (having conductivity of less than 10 $\mu\text{S} / \text{cm}$).</p> <p>If you have a water conductivity meter, check the quality of the water before refilling the reservoir.</p> <p>To empty the reservoir, see <i>Section 9.13 Preparing the Unit for Shipping</i>.</p>
Machine will not start, red X on Water Level.	Water reservoir level is too low.	If water level is too low: Refill the reservoir. Refer to the steps described in <i>Section 2.4 Filling your STATIM B's Water Reservoir</i> .

Problem	Possible Cause	What you can check before calling for service
Instruments do not dry.	<p>Improper loading.</p> <p>Wrong cycle selection for this particular load.</p> <p>Chamber draining issues.</p>	<p>NOTE: For optimal drying, allow the cycle to continue to completion.</p> <p>Make sure the instruments are loaded correctly in the chamber. Refer to <i>Section 4 Loading Instruments</i>.</p>
Unit's total cycle time is too long.	<p>Unit is starting with a cold chamber.</p>	<p>From a cold start, the unit's total cycle time can take as much as 10 additional minutes. Reduce the warm-up time between cycles or set the unit to warm-up at a specific time in the morning. See <i>Section 7.3 Setting the Stand-by Mode</i>.</p>
Instruments show traces of oxidation or spotting.	<p>Low quality instruments.</p>	<p>Instruments made of inferior materials can be prone to discolouration. Check the quality of the instruments that are spotting. Verify that they can tolerate steam sterilisation.</p>
	<p>Inadequate water quality.</p>	<p>Drain the clean water reservoir and refill it with high-quality distilled water.</p>
	<p>Organic or inorganic residues on the instruments.</p>	<p>Instruments must be free of debris prior to sterilisation. Clean and rinse all instruments before loading them into the steriliser. Disinfectant residues and solid debris may inhibit sterilisation and damage the instruments. Lubricated instruments must be wiped thoroughly, and any excess lubricant should be removed before loading.</p>
	<p>Contact between instruments made of different metals.</p>	<p>Arrange instruments made of different metals (stainless steel, tempered steel, aluminum, etc.) on different trays or keep them well separated from each other.</p>
Unit is using too much water.	<p>Unit is overloaded.</p>	<p>See <i>Section 4. Loading Instruments</i> for details on capacity.</p>
Drawer will not close.	<p>Item obstruction.</p>	<p>Check for an instrument, a pouch or a cassette that is keeping the drawer from closing correctly.</p> <p>Check the drawer seal to make sure it is properly seated. To re-seat the drawer seal, see <i>Section 9.8 Replacing the Drawer Seal</i>.</p>
Drawer will not close - No obstructions.	<p>Chamber pressure balance issue.</p>	<p>Leave the drawer open for 1 minute and try again.</p>
Handle in latched position but drawer not showing 'locked'.	<p>The drawer will lock once a cycle is selected.</p>	<p>Press a cycle button to initiate the drawer lock microswitch.</p>
Touchscreen remains on WARMING UP CHAMBER screen.	<p>Band heaters were not on.</p> <p>From a cold start, the unit can take approximately 10 minutes to warm up. The chamber needs to be above 50°C and the band heaters need to be at 120°C or more.</p>	<p>Go to SETTINGS and select STAND-BY. Change unit Stand-by setting to HIGH.</p>

11 Ordering Spare Parts and Accessories

Spare Parts	
01-116292S	Bacteriological Air Filter
01-116293S	Drawer Seal, 6L
01-116294S	Tray, 6L
01-116296S	Exhaust Tube
01-116297S	Extended Exhaust Tube
01-116298S	Direct-to-Drain
01-116299S	Water Filling
01-116300S	Waste Bottle
01-116301S	USB Memory Stick
01-116302S	Water Reservoir Cap
SCI-BDSK134V	Bowie-Dick Test Kit
97902001	Helix Test Kit with 100 Chemical Indicators
97902002	Helix Test Kit with 400 Chemical Indicators
01-110282S	Power Cord EU 16A/250V
01-110285S	Power Cord UK IND plug 16A/250V
01-116617S	Filter, Water Reservoir
01-116497S	Chamber Filter
01-116501S	STATIM B Maintenance Kit (1 bacteriological air filter, 1 drawer seal, 1 chamber filter)

12 Limited Warranty

For a period of 2 years or 4,000 cycles, which ever appears first, the legal manufacturer, Dent4You AG, guarantees that the STATIM B autoclave, when manufactured in new and unused condition, will not fail during normal service due to defects in material and workmanship that are not due to apparent abuse, misuse, or accident.

The five year warranty will cover the performance of all components of the unit except consumables such as the bacteriological filter, reservoir filter and trays, and provided that the product is being used and maintained according to the description in the operator's manual.

The legal manufacturer warrants to the original purchaser that the drawer and drawer seal will be free from defects in material and workmanship under normal use and service for a period of 1 year or 2,000 cycles, whichever appears first.

In the event of failure due to a component defect during this period of time, the exclusive remedies shall be repaired or replaced, at the legal manufacturer's option and without charge, of any defective non-consumable part(s) (except seal), provided the legal manufacturer is notified in writing within thirty (30) days of the date of such a failure and further provided that the defective part(s) are returned to the legal manufacturer, prepaid.

This warranty shall be considered to be validated if the product is accompanied by the original purchase invoice from the authorized dealer, and such invoice identifies the item by serial number and clearly states the date of purchase. No other validation is acceptable.

After two years or 4,000 cycles, whichever occurs first, all warranties and other duties with respect to the quality of the product shall be conclusively presumed to have been satisfied. All liability therefore shall be terminated, and no action or breach of any such warranty or duty may thereafter be commenced against the legal manufacturer.

Any express warranty not provided hereon and any implied warranty or representation as to performance, and any remedy for breach of contract which, but for this provision, might arise by implication, operation of law, custom or trade or course of dealing, including any implied warranty of merchantability or of fitness for particular purpose with respect to all and any manufactured products is excluded and disclaimed by the legal manufacturer.

If you would like to learn more about our products and features, to register your warranty online, or make a warranty claim, visit our website at www.scican.com.

13 Specifications

Machine Dimensions:	Width: 40.6 cm / 16" Height: 20 cm / 7.9" Depth: 58 cm / 22.8"
Drawer Dimensions:	Width: 21 cm / 8.25" Depth: 30 cm / 11.8"
Sterilisation Chamber Volume:	6L (61 cubic inches)
Distilled Water Reservoir Volume:	1.2L (0.32 US gal)
Weight (without water):	24 kg (54 lbs)
Weight (with full reservoirs and full load):	27.8 kg (61.3 lbs)
Clearance Required:	Top: 5 cm (2") Right Side: 5 cm (2") Left Side: 5 cm (2") Front (to open drawer): 28 cm (11") Back: 5 cm (2")
Water Quality:	≤ 6.4 ppm / 10 µS/cm (conductivity at 25°C / 77°F)
Minimum Distilled Water Volume required for cycle:	0.3L (0.8 US gal)
PRV Value (pressure relief valve):	Set at 2.5 bar gauge / 36.26 PSIG to release pressure in overpressure situations
Electrical Rating:	230V ~50Hz, 12A
Maximum Power Consumption:	3.4 kVA for 208-240V 1.0 kWh
Ethernet Port:	10/100/1000 Base-T
WiFi:	2.4 GHz, 5 GHz
USB Port:	USB 2.0
Current:	AC
Protection Class:	I
Protection:	Covered
Ambient Operating Temperature:	5°C to 40°C (41°F to 104°F)
Sound Levels:	< 60 dB
Humidity:	80% for temp. up to 31°C, 50% for temp. up to 40°C
Maximum Altitude:	2000 m (6562 ft)

14 Sterilisation Cycle Profiles in Graph Format

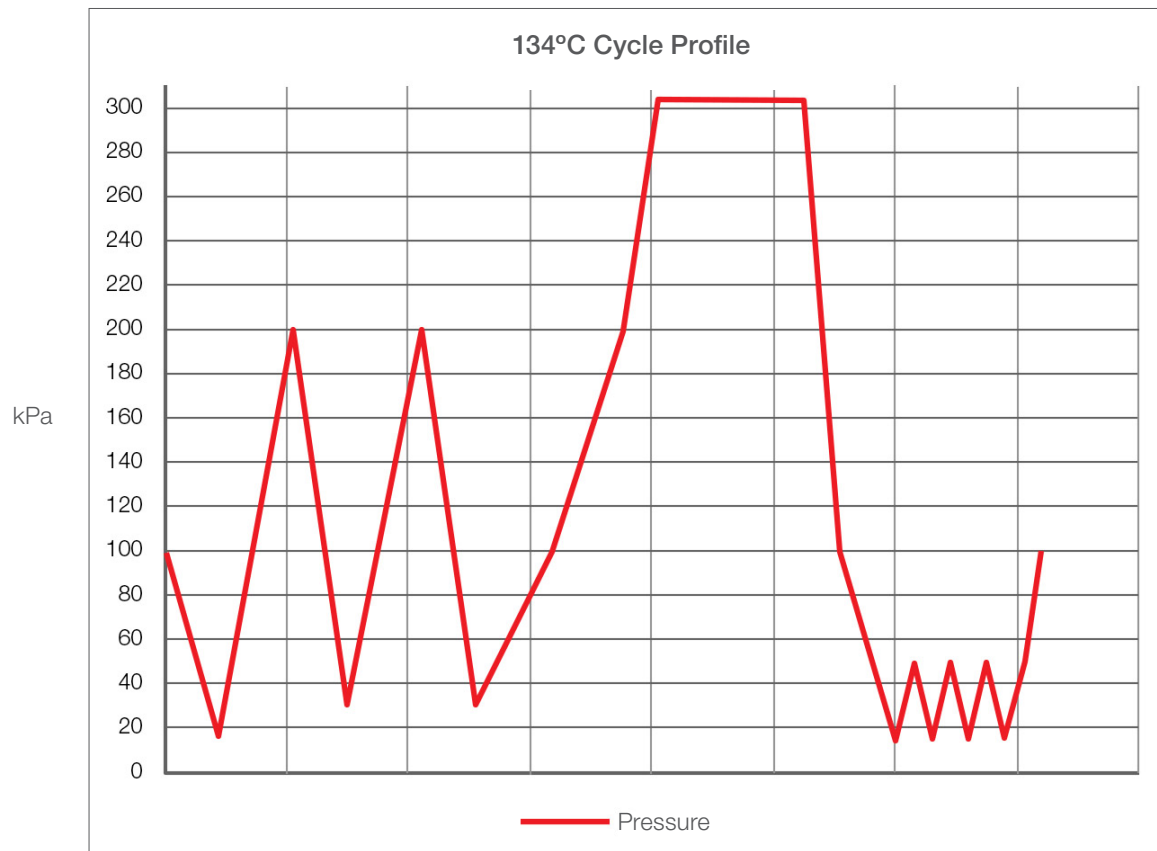
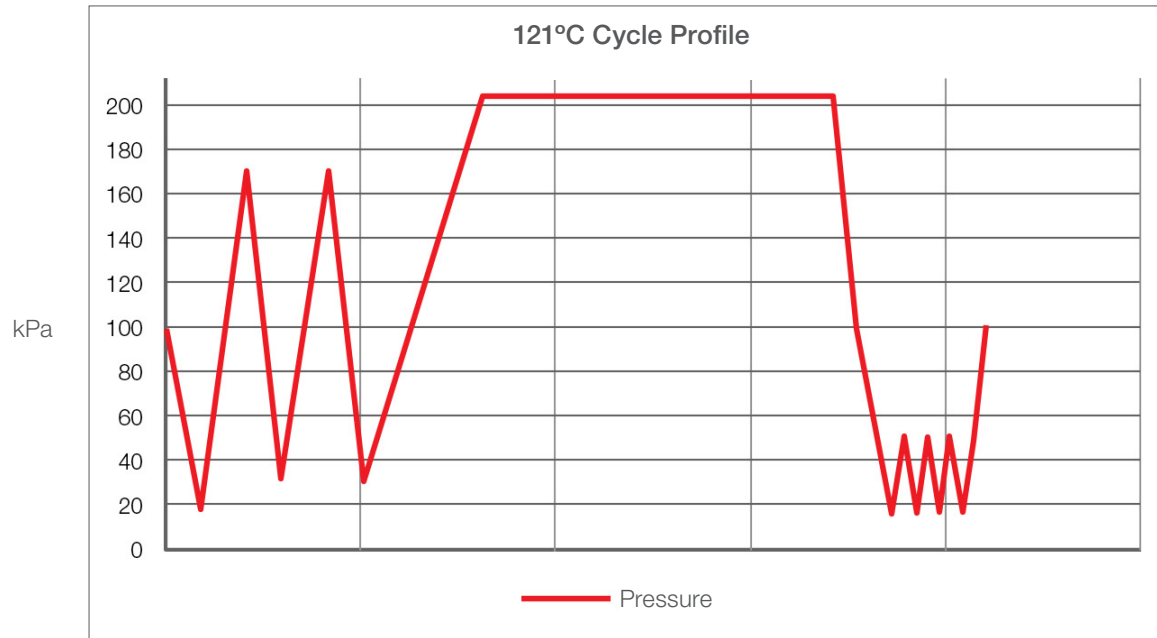

15 Declaration of Conformity

Basic UDI-DI: 764018507STATIMBVQ

Classification: Class IIa [(EU) 2017/745 Annex VIII, Rule 16)]

Legal Manufacturer: Dent4You AG

Legal Manufacturer Address: Bahnhofstrasse 2
CH-9435 Heerbrugg

European Representative: Coltène/Whaledent GmbH+Co. KG
Raiffeisenstraße 30
DE-89129 Langenau

We herewith declare that the above mentioned products meet the provisions of the following EC legislation(s) and that the legal manufacturer has exclusive responsibility for the content of this Declaration of Conformity. All supporting documentation is retained at the manufacturer's premises.

General Applicable Legislation:

Medical Device Regulations: Regulation (EU) 2017/745 of 5 April 2017 on medical devices (MDR 2017/745, Annex IX, Chapters I, III including Section 4).

Standards and Common Specifications:

EN ISO 13485, EN 61010-1, EN 61010-2-040, EN ISO 14971, EN 62304, EN 62366-1, EN 13060, EN 61326-1.

Notified Body: TÜV SÜD Product Service GmbH
Ridlerstraß 65,
D-80339 München, Deutschland
Identification No. 0123

Date CE Mark was affixed: April 12, 2021